

chemfig

v1.5

5 march 2020

Christian Tellechea

unbonpetit@netc.fr

A T_EX package for drawing molecules

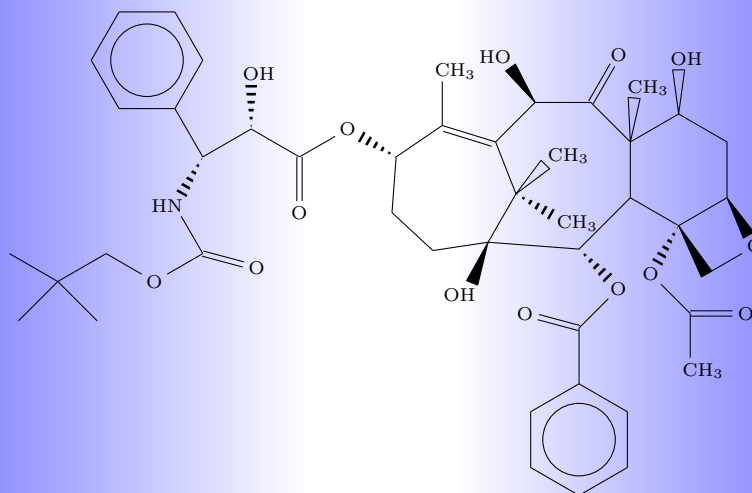

Taxotere

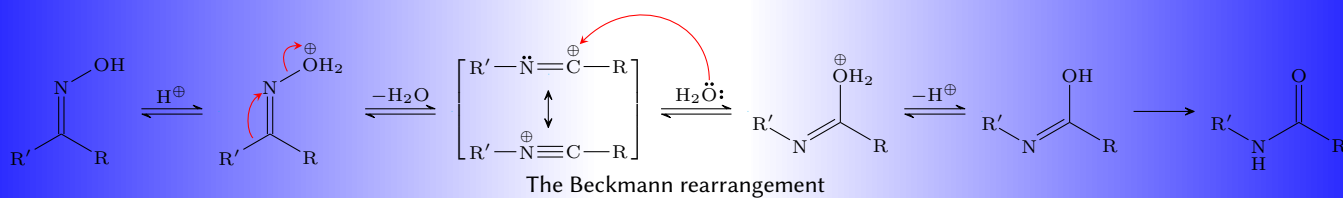

Contents

I	Introduction	4
1	New in v1.5	4
1.1	The macro <code>\charge</code>	4
1.2	Consecutive bonds	4
1.3	Manual Update	4
2	Presenting <code>chemfig</code>	5
3	Acknowledgment	5
II	Operation of <code>chemfig</code>	6
1	The <code>\chemfig</code> macro	6
2	Groups of atoms	7
3	First atom's role	7
4	Different types of bonds	7
5	Bond angle	9
5.1	Predefined angles	9
5.2	Absolute angles	9
5.3	Relative angles	10
6	Length of a bond	10
7	Departure and arrival atoms	11
8	Customization of bonds	12
9	Default values	12
10	Branches	13
10.1	Principle	13
10.2	Nesting	14
10.3	Method	14
11	Connecting distant atoms	15
12	Rings	16
12.1	Syntax	16
12.2	Angular position	17
12.2.1	At the start	17
12.2.2	After a bond	18
12.3	Branches on a ring	18
12.4	Nested rings	19
12.5	Rings and groups of atoms	20
13	Representing electron movements	20
13.1	Mesomeric effects	21
13.2	Reaction mechanisms	23
14	Writing a name under a molecule	23

III	Advanced usage	25
1	Separating atoms	25
2	Displaying atoms	25
3	Arguments given to tikz	26
4	Shifted double bonds	26
5	Delocalized double bonds	27
6	Saving a sub-molecule	27
7	Placement of Atoms	29
7.1	First Atom	29
7.2	Groups of atoms	29
7.3	Bonds between atoms	30
7.4	La macro <code>\chemskipalign</code>	31
8	The macro <code>\charge</code>	32
8.1	Overview	32
8.2	Parameters	32
8.3	Lewis formula	33
8.4	Integration in <code>chemfig</code>	34
9	Stacking	34
10	Using <code>\chemfig</code> in the <code>tikzpicture</code> environment	35
11	Annotated examples	35
11.1	Ethanal	35
11.2	2-amino-4-oxohexanoic acid	36
11.2.1	Absolute angles	36
11.2.2	Relative angles	36
11.2.3	Ring	37
11.2.4	Nested rings	37
11.3	Glucose	37
11.3.1	Skeleton diagram	38
11.3.2	Fisher projection	38
11.3.3	“Chair” representation	39
11.3.4	Haworth projection	39
11.4	Adrenaline	40
11.4.1	Using one ring	40
11.4.2	Using two rings	41
11.5	Guanine	42
12	How to ...	43
12.1	Write a colored atom	43
12.2	Add a superscript without modifying a bond	43
12.3	Draw a curve bond	44
12.4	Draw a polymer element	44
12.5	Draw the symmetrical of a molecule	46
12.6	Add text above bonds and arc to angles	46
12.7	Dessiner des liaisons multiples	47
IV	Reaction schemes	47
1	Overview	48

2 Arrow types	48
3 Arrows features	49
4 Compounds names	50
5 Anchoring	50
6 Compounds style	52
7 Branching	52
8 Subscheme	53
9 Arrows optional arguments	56
10 Arrows customization	58
10.1 First arrow	58
10.2 Curved arrow	59
11 The \merge command	60
12 The + sign	62
V List of commands	65
VI Gallery	67

Introduction

1 New in v1.5

1.1 The macro `\charge`

Version 1.5 implements the macros `\charge` and `\Charge` (see page 32) whose purpose is to place arbitrary elements around an atom that can be placed with great precision. These macros will replace the `\lewis` and `\Lewis` macros because they are much more powerful and configurable, even if more verbose. It is therefore important to note that the macros `\lewis` and `\Lewis` **are no longer documented and will be removed from the chemfig package**.

La macro `\charge`

```
Simple charges around A :
\Charge{0=\:,
        0:3pt[anchor=180]=\color{red}\scriptstyle\delta^+$,
        120={["width=2pt,"style={draw=green,fill=gray}]},
        210=\|
        }{A}

\par
Complex charges around "B" :
\Charge{%
  30:10pt={\chemfig[atom sep=6pt,double bond sep=1.5pt][[:20]*6(==--=)}},
  120:5pt[scale=0.4,rotate=30,anchor=center]=\chemfig{CH_2=CH_2},
  -45[anchor=west,rotate=\chargeangle]={%
    \begin{tikzpicture}
      \node[anchor=mid west](a){$\oplus$};\draw[-stealth](a)--(-.5,0);
    \end{tikzpicture}}%
  }{B}
```

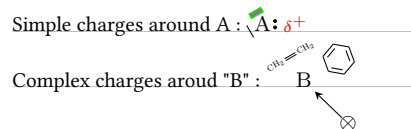

1.2 Consecutive bonds

As of version 1.5, two bonds are joined if the atom between them has all its dimensions equal to zero (i.e. width, height and depth in the sense of \TeX). Previously, two bonds were joined if the atom was *empty*, which was more restrictive.

Together with the use of the macro `\charge`, this new feature makes it possible to place charges in a chain without using invisible bonds.

Consecutive bonds

```
\chemfig{[:30]-\charge{90=\:}}
-[:30]\charge{-90=\:}-\charge{90:2pt=\delta^+}-[:30]
```

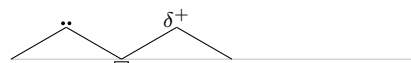

1.3 Manual Update

More detailed explanations are given on:

- the role played by the first atom encountered in the placement of the whole molecule (page 7 and 29);
- how chemfig places the atoms in a group of atoms (page 29);
- how a bond joins two atoms (page ??).

2 Presenting chemfig

To use this package, start by adding the following code to the preamble:

- `\input chemfig.tex` with $\epsilon\text{T}_{\text{E}}\text{X}$;
- `\usepackage{chemfig}` with $\text{L}^{\text{A}}\text{T}_{\text{E}}\text{X}$;
- `\usemodule[chemfig]` with $\text{ConT}_{\text{E}}\text{Xt}^*\text{ConT}_{\text{E}}\text{Xt}@\text{ConT}_{\text{E}}\text{Xt}$.

In all cases, the `tikz` package, if not loaded before, is loaded by `chemfig`.

The most important command for drawing molecules is `\chemfig{⟨code⟩}`. The argument `code` is a set of characters describing the structure of the molecule according to the rules which are described in this manual.

Care has been taken to make it possible to draw the greatest possible number of molecular configurations, while maintaining a simple, flexible, and intuitive syntax. Despite this, the `⟨code⟩` which describes the 2D structure of the molecule increases in complexity in proportion to that of the molecule being drawn.

The command `\chemfig` draws a molecule using the commands provided by the `tikz` package, placed inside a `tikzpicture` environment. The choice of `tikz` implies that:

- the user has a choice of compilation method: $\text{pdfL}^{\text{A}}\text{T}_{\text{E}}\text{X}$ can be used equally well in `dvi mode` (`tex` \rightarrow `dvi` \rightarrow `ps` \rightarrow `pdf`) or in `pdf mode` (`tex` \rightarrow `pdf`). In effect `tikz`, via the underlying `pgf`, gives identical graphical results in the two modes;
- the bounding box is automatically calculated by `tikz` and the user need not worry about any overlap with the text. However, care must be taken with alignment when the molecule is drawn in a paragraph. In the

following example, we have drawn the bounding box for the molecule:

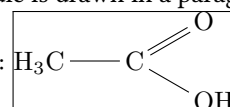

3 Acknowledgment

This package has seen the light of day thanks to the assistance of Christophe CASSEAU, who had the idea. I thank him for his help before writing the code and for the tests he carried out.

I also want to warmly thank Theo HOPMAN for offering to translate this manual into English.

Operation of chemfig

This part is devoted to describing the most common features of chemfig. The user will find here explanations sufficient to draw most molecules. The presentation of features is done from a theoretical angle, and the goal of this part is not to draw real molecules but to give the user a formal description of the functionality of chemfig. The “Advanced usage”, page 25, will be more practical and will illustrate advanced features for the most demanding uses. It will also highlight methods of building real molecules, page 35. Finally, the last part will give examples of molecules and the code used to draw them.

1 The `\chemfig` macro

The macro `\chemfig` has the following syntax

$$\backslash\text{chemfig}[\text{list of } \langle\text{keys}\rangle=\langle\text{values}\rangle]\{\langle\text{molecule code}\rangle\}$$

The optional argument in square brackets sets the parameters used for this molecule. It should be noted that the parameters are only modified for the current molecule and will be restored to their previous values after the macro has been executed. To permanently modify parameters, the macro `\setchemfig{\langle\text{key}\rangle=\langle\text{values}\rangle}` should be used.

Here is the complete list of parameters as well as their default values. It should be noted that the $\langle\text{keys}\rangle$ from [scheme debug](#) included to the end of the list concern reaction schemes and make no sense in the optional argument of the macro `\chemfig` where they are simply ignored:

$\langle\text{keys}\rangle$	default $\langle\text{values}\rangle$	$\langle\text{keys}\rangle$	default $\langle\text{values}\rangle$
<code>chemfig style</code>	$\langle\text{empty}\rangle$	<code>lewis radius</code>	0.15ex
<code>atom style</code>	$\langle\text{empty}\rangle$	<code>lewis diag coeff</code>	1
<code>bond join</code>	false	<code>cycle radius coeff</code>	0.75
<code>fixed length</code>	false	<code>stack sep</code>	1.5pt
<code>cram rectangle</code>	false	<code>scheme debug</code>	false
<code>cram width</code>	1.5ex	<code>compound style</code>	$\langle\text{empty}\rangle$
<code>cram dash width</code>	1pt	<code>compound sep</code>	5em
<code>cram dash sep</code>	2pt	<code>arrow offset</code>	4pt
<code>atom sep</code>	3em	<code>arrow angle</code>	0
<code>bond offset</code>	2pt	<code>arrow coeff</code>	1
<code>double bond sep</code>	2pt	<code>arrow style</code>	$\langle\text{empty}\rangle$
<code>angle increment</code>	45	<code>arrow double sep</code>	2pt
<code>node style</code>	$\langle\text{empty}\rangle$	<code>arrow double coeff</code>	0.6
<code>bond style</code>	$\langle\text{empty}\rangle$	<code>arrow double harpoon</code>	true
<code>lewis width</code>	0.3ex	<code>arrow label sep</code>	3pt
<code>lewis sep</code>	0.4ex	<code>arrow head</code>	-CF
<code>lewis length</code>	1.5ex	<code>+ sep left</code>	0.5em
<code>lewis style</code>	$\langle\text{empty}\rangle$	<code>+ sep right</code>	0.5em
<code>lewis dist</code>	0.3em	<code>+ vshift</code>	0pt

The $\langle\text{molecule code}\rangle$ contains instructions for drawing the molecule according to a syntax that will be explained in this document. There are no restrictions on the characters accepted in the code:

- all catcode 11 or 12 characters, i. e. upper and lower-case letters, numbers, mathematical operators (+ - * / =), punctuation marks whether active or not (. , ; : ! ? ' ' " |), parenthesis and brackets;

- more special characters such as "~", "#"¹ as well as "^" and "_" which have their normal mathematical mode properties;
- spaces, but these are ignored by default because the atoms are composed in mathematical mode;
- the "{" and "}" braces that have their normal behavior as group markers or macro argument delimiters;
- macros.

2 Groups of atoms

Drawing a molecule consists inherently of connecting groups of atoms with lines. Thus, in the molecule $O=O$, there are two groups of atoms, each consisting of a single atom "O".

However, in this molecule

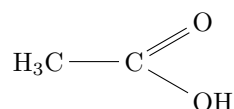

there are four groups of atoms: "H₃C", "C", "O" and "OH". For reasons which we shall see later, `chemfig` splits each group into single atoms. Each atom extends up to the next capital letter or one of these special characters: `☐ ☒ ☓ ☔ ☕ ☖ ☗ ☘`. `chemfig` ignores all characters inside braces when splitting groups into atoms.

Therefore the first group of atoms "H₃C" is split into two atoms: `☐H☐☐☐` and `☐C☐`. In terms of chemistry, of course, these are not real atoms; H₃, for example, consists of three hydrogen atoms. In what follows the word atom refers to `chemfig`'s definition. Thus `chemfig` sees the preceding molecule as follows:

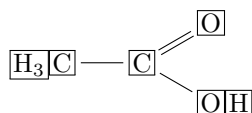

A space is ignored when at the beginning of a group of atoms.

3 First atom's role

It is important to understand that the placement of the entire molecule depends on the first atom placed, i.e. the first atom of the first group of atoms. For this first atom, its `tikz` anchor "base east" is placed on the baseline of the current line (drawn in gray in the examples of this manual).

Influence of the first atom

```
\chemfig{A-B}\qqquad
\chemfig{-B}\qqquad
\chemfig{A^1-B}
```



4 Different types of bonds

For `chemfig`, bonds between two atoms are one of nine types, represented by the characters `☐`, `☒`, `☓`, `☔`, `☕`, `☖`, `☗`, `☘`, `☙` and `☚`:

Bond #	Code	Result	Bond type
1	<code>\chemfig{A-B}</code>	A — B	Single
2	<code>\chemfig{A=B}</code>	A = B	Double
3	<code>\chemfig{A~B}</code>	A ≡ B	Triple
4	<code>\chemfig{A>B}</code>	A ► B	right Cram, plain
5	<code>\chemfig{A<B}</code>	A ◄ B	left Cram, plain
6	<code>\chemfig{A>:B}</code>	A B	right Cram, dashed
7	<code>\chemfig{A<:B}</code>	A ··· B	left Cram, dashed
8	<code>\chemfig{A> B}</code>	A ▷ B	right Cram, hollow
9	<code>\chemfig{A< B}</code>	A ◁ B	left Cram, hollow

¹To avoid that # is doubled when the macro `\chemfig` is in the argument of a macro, instead of #, the macro `\#` or the macro `\CFhash` can be used.

The `<key>` `double bond sep=<dim>` adjusts the spacing between the lines in double or triple bonds. This spacing is 2pt by default.

We must understand that when a bond is made between two atoms, these atoms are contained within invisible rectangular boxes. The centers of these two rectangles are separated by an adjustable distance Δ called the “interatomic distance”. Furthermore, bonds do not connect to the exact edges of the rectangles: a length δ , also adjustable, separates the edges of the rectangles and the beginning and end of the bond line. The rectangular boxes are made visible in the diagram below to help understanding.

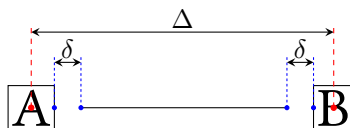

The `<key>` `atom sep = <dim>` adjusts the interatomic distance Δ . This setting, like all other settings, affects all the following molecules.

Interatomic distance

```
\chemfig[atom sep=2em]{A-B}\par
\chemfig[atom sep=50pt]{A-B}
```

A — B
A ————— B

The `<key>` `bond offset = <dim>` sets the spacing δ between the bond line and the atom. Its default value is 2pt.

Trimming bonds

```
\chemfig[bond offset=0pt]{A-B}\par
\chemfig[bond offset=5pt]{A-B}
```

A — B
A — B

If one bond is followed immediately by another, then `chemfig` inserts an empty group `{}`. Around this empty group the separation δ is zero:

Empty groups

```
\chemfig{A-B==C}
```

A — B = C

The `<key>` `bond style = <tikz code>` sets the style for all the bonds drawn thereafter. The `<tikz code>` is empty by default. To custom a single bond, see page 12.

Style of bonds

```
\chemfig[bond style={line width=1pt,red}]{A-B=C>|D<E>:F}
```

A — B = C > D < E : F

The spacing δ for just one bond can be specified with the character `#`. This character must be placed *immediately* after the bond symbol and has one required argument between parentheses of the form “`#(<dim1>, <dim2>)`”, where `<dim1>` is the spacing δ at the beginning of the bond and `<dim2>` is the that at the end. If `<dim2>` is omitted, the spacing at the end of the bond takes the value of δ in effect at that time. One can see in the example how the shortening, set to 4pt to be more visible, is nullified for the bond arriving at “B”, then for the one leaving “B”, and finally for both:

Fine adjustment of bond shortening

```
\setchemfig{bond offset=4pt}
\chemfig{A-B-C}\par
\chemfig{A-#(,0pt)B-C}\par
\chemfig{A-B-#(0pt)C}\par
\chemfig{A-#(,0pt)B-#(0pt)C}
```

A — B — C
A — B — C
A — B — C
A — B — C

By default, all atoms within groups of atoms are typeset in `math mode` (spaces are ignored). They may therefore contain `math mode` specific commands such as subscripts or superscripts²:

Math mode

```
\chemfig{A_1B^2-C _ 3 ^ 4}
```

A₁B² — C₃⁴

There are settings specifically for Cram bonds:

- `cram width = <dim>` is the size of the base of the triangle, and is 1.5pt by default;
- `cram dash width = <dim>` is the thickness of the dots, and is 1pt by default;
- `cram dash sep = <dim>` is the spacing between the dots, and is 2pt by default.

Here is an example where the three dimensions are changed:

²There is a problem with the placement of groups of atoms containing exponents or subscripts. See page ??.

Modified Cram bonds

```
\chemfig[cram width=10pt,  
cram dash width=0.4pt,  
cram dash sep=1pt]{A>B>:C>|D}
```

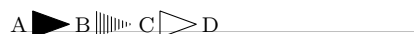

5 Bond angle

Each bond takes an optional argument in brackets. This optional argument can adjust every aspect of a bond, and consists of five optional fields separated by commas. The first of these fields defines the bond angle. Angles increase counterclockwise, and are relative to the horizontal. If the angle field is empty, the angle takes its default value of 0° . We will see later how to change this default.

There are several ways of specifying the bond angle.

5.1 Predefined angles

When the angle field contains an integer, this represents the angle the bond makes relative to the horizontal, in multiples of 45° . For example, `[0]` specifies an angle of 0° , `[1]` is 45° , and so on.

Predefined angles

```
\chemfig{A-B-[1]C-[3]D-[7]E-[6]F}
```

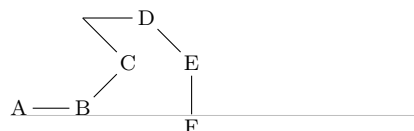

These angles remain valid if the atoms are empty, and this is the case for all the features we will see below:

Predefined angles with empty groups

```
\chemfig{--[1]-[3]--[7]-[6]}
```



For those who find this "ugly"³, it is now possible connect the single bonds with a slightly increased compilation time. The boolean `<key> bond join = <boolean>` macro enables this feature when `<true>` and disables it when `<false>`, which is the better behavior, set by default.

Connecting bonds

```
\setchemfig{bond style={line width=3pt}}  
\chemfig{--[1]-[7]} et  
\chemfig[bond join=true]{--[1]-[7]}
```



The `<key> angle increment = <angle>` sets the default angle used to calculate the angle of a bond:

Set the predefined angle

```
Default (45) : \chemfig{--[1]-[1]-[1]-[1]}
```

```
Angle of 30 : \chemfig[angle increment=30]{--[1]-[1]-[1]-[1]}
```



5.2 Absolute angles

If one wishes to specify an angle in degrees relative to the horizontal, then the optional angle field must take this form: `[:<absolute angle>]`. If necessary, the `<absolute angle>` is reduced to the interval $[0, 360)$:

³See <http://tex.stackexchange.com/questions/161796/ugly-bond-joints-in-chemfig-detokenize>

Absolute angles

```
\chemfig{A-[:30]B=[:75]C-[:10]D-[:90]>|[:60]-[:20]E-[:0]~[:75]F}
```

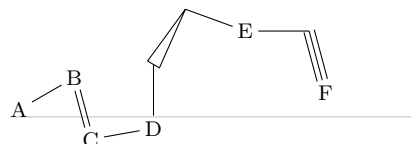

5.3 Relative angles

It is often useful to specify a bond angle relative to the preceding bond. This syntax must be then be used: `[:<relative angle>]`. The sign of the `<relative angle>` can be omitted if it is a +.

Here is a molecule where the first bond has an absolute angle of -5° , and the rest of the bond angles are incremented by 20° :

Result of relative angles

```
\chemfig{A-[:5]-[:20]-[:20]B-[:20]-[:20]C-[:20]}
```

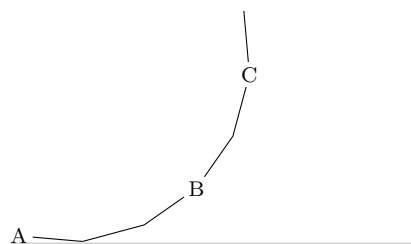

One can “break” a chain of relative angles by putting an absolute or predefined angle where desired. Here, atom “B” is followed by a bond at an absolute angle of 315° .

Result of relative angles followed by absolute

```
\chemfig{A-[:5]-[:20]-[:20]B-[7]-[:20]C-[:20]}
```

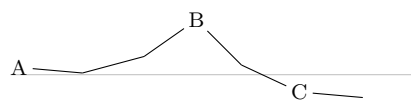

6 Length of a bond

Rather than speaking of length of a bond, we should use the term interatomic spacing. If effect, only the interatomic spacing is adjustable with `atom sep` as we have seen on page 8. Once this parameter is set, the length of a bond depends on the content of atoms and, to a lesser extent, the angle the bond makes with the horizontal. It should be obvious that two “slimmer” atoms will have larger edge separations than two which are larger. This can be seen easily in the following example where an “I” atom is narrower than an “M” atom, which means that the bond between the “I” atoms is longer than that between the “M” atoms:

Influence of the size of atoms

```
\chemfig{I-I}\par  
\chemfig{M-M}
```



This aspect of the size of atoms becomes particularly acute when the atom involves subscripts or superscripts. In this example, the bond is extremely short, to the point of confusion with a negative sign `-`:

Too-short bond

```
\chemfig{A^{++}_{2}-B^{-}_{3}}
```



It is important to note that the exponent `-` is *put inside braces*. If this were not done, `chemfig` would stop the atom on this character, which is a bond character. The atom would then be “B^”, which would lead to unexpected results.

It is possible to change the behavior of `chemfig` about the interatomic spacing. Indeed, when the `\chemfig` macro is immediately followed by a star, the `<key>` `atom sep` no longer defines the distance between the centers of atoms, denoted Δ , but *length of the bonds*. Consequently, the bonds have fixed lengths while the distance between the centers of the atoms is variable and depends on their size. Here is the diagram on page 8 and what becomes with the two boolean values of key `fixed length`:

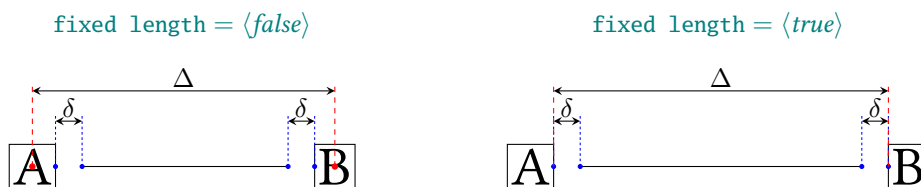

In rings, even when `fixed length = <true>`, the default behavior is restored for the bonds of the cycle, in order to draw regular polygons.

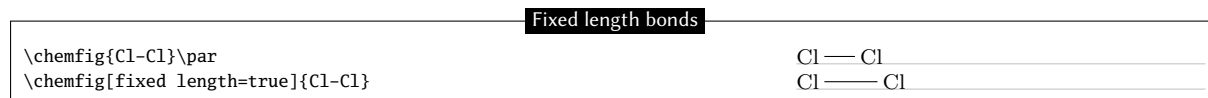

Especially with the default behavior, to avoid too short bonds, it is sometimes necessary to increase (or perhaps reduce) the interatomic distance. For this, the optional argument to bonds is actually made up of several comma-separated fields. As we have seen, the first field specifies the angle. The second field, if it is not empty, is a coefficient which multiplies the default interatomic distance Δ . Thus, writing `-[,2]` asks that this bond have the default angle (first field is empty) and that the atoms it connects be separated by twice the default distance.

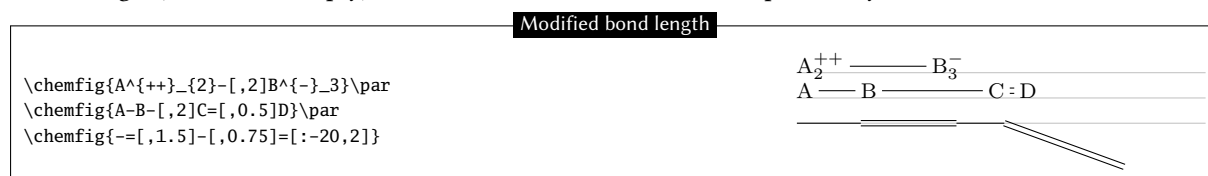

We can change the size of molecules by altering the font size or the `<key>` `atom sep`, possibly on both, being careful to confine these changes within a group if we want to limit the scope:

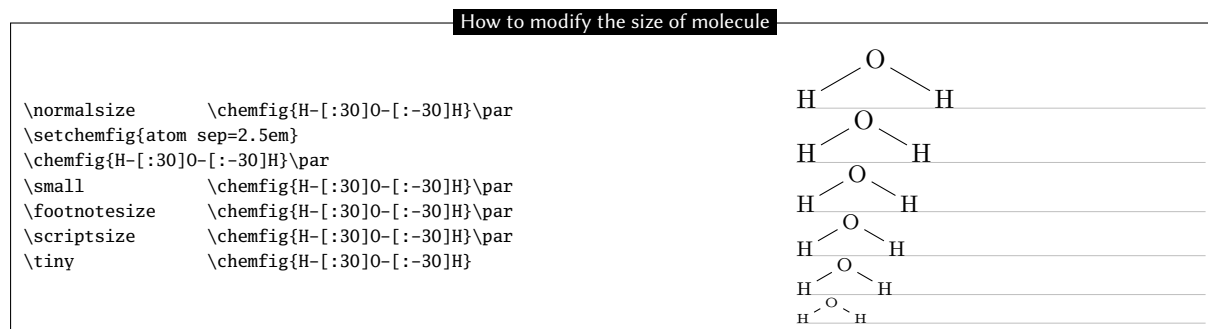

7 Departure and arrival atoms

A group of atoms can contain several atoms. Suppose we want to connect the group “ABCD” to the group “EFG” with a bond. `chemfig` calculates which atom of the first group and which of the second group are to be connected by looking at the angle of bond relative to the horizontal. If the angle is between (but not including) -90° and 90° (modulo 360°) then the bond is made between the last atom of the first group and the first atom of the second group. In all other cases, the bond is made between the first atom of the first group and the last atom of the second group.

Here are some examples where the bond is in the interval $(-90, 90)$, and where the bond is made between D and E:

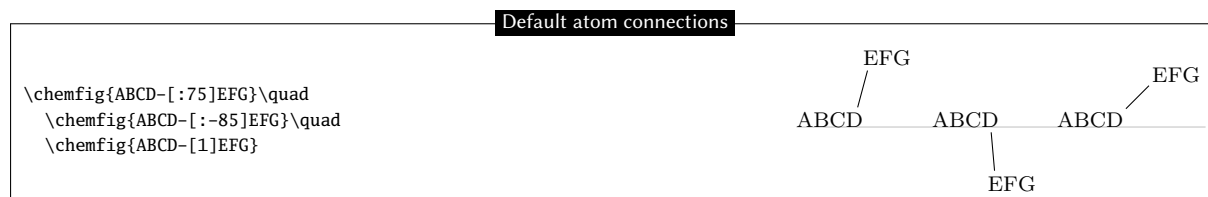

In the following examples, the angles are in the interval $[90, 270]$ and so the bond is made between A and G:

Default atom connections

```
\chemfig{ABCD-[:100]EFG}\quad
\chemfig{ABCD-[:-110]EFG}\quad
\chemfig{ABCD-[5]EFG}
```

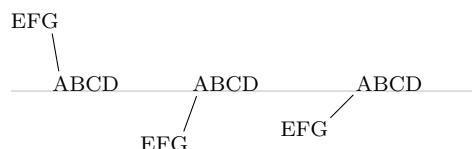

One may sometimes want the bond partners to be atoms other than those determined by `chemfig`. The departure and arrival atoms can be set with the optional bond argument by writing:

$$[,,, \langle integer\ 1 \rangle, \langle integer\ 2 \rangle]$$

where $\langle integer\ 1 \rangle$ and $\langle integer\ 2 \rangle$ are the numbers of the desired departure and arrival atoms. These atoms must exist, otherwise an error message will be given.

Specified atom connections

```
\chemfig{ABCD-[:75,,2,3]EFG}\quad
\chemfig{ABCD-[:-75,,2]EFG}\quad
\chemfig{ABCD-[:75,,3,2]EFG}
```



8 Customization of bonds

There is a fifth and last optional argument for bonds which is found after the fourth comma:

$$[,,,, \langle tikz\ code \rangle]$$

This $\langle tikz\ code \rangle$ is passed directly to `tikz` when the bond is drawn. There one can put characteristics such as colour (`red`), dash type (`dash pattern=on 2pt off 2pt`), thickness (`line width=2pt`), or even decoration if the `tikz decoration` library has been loaded. A bond can be made invisible by writing “`draw=none`”. To set several attributes, the syntax of `tikz` is used, separating them by a comma:

Passing tikz code

```
\chemfig{A-[,,,red]B}\par
\chemfig{A-[,,,dash pattern=on 2pt off 2pt]B}\par
\chemfig{A-[,,,line width=2pt]B}\par
\chemfig{A-[,,,red,line width=2pt]B}
```



Numerous `tikz` decoration libraries are available. For example, one can use the “`pathmorphing`” library by putting `\usetikzlibrary{decorations.pathmorphing}` in the preamble in order to draw wavy bonds:

Wavy bonds

```
\chemfig{A-[ ,3,,decorate,decoration=snake]B}
```



Cram bonds ignore thickness and dash settings.

9 Default values

At the beginning of each molecule, the default values for the optional arguments are initialized. They are:

- 0° for the bond angle;
- 1 for the length multiplication coefficient;
- $\langle empty \rangle$ for the numbers of the departure and arrival atoms, which lets `chemfig` calculate these based on the bond angle;
- $\langle empty \rangle$ for the parameters passed to `tikz`.

These default values can be changed for the whole molecule by beginning the molecule code with

$$[\langle angle \rangle, \langle coeff \rangle, \langle n1 \rangle, \langle n2 \rangle, \langle code\ tikz \rangle]$$

Thus, if the code of a molecule begins with `[:20,1.5]`, then all the bonds will be at angle of 20° by default, and the interatomic distances will have a length 1.5 times the default length. These default values can be overridden at any time by giving an optional argument, such as for the bond which follows atom “`C`” in this example:

Overriding default values

```
\chemfig{[:20,1.5]A-B-C-[:-80,0.7]D-E-F}
```

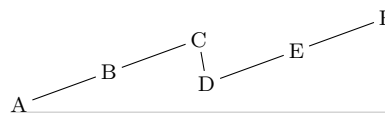

If something odd like `[1,1.5,2,2,red,thick]` is written, then unless otherwise indicated all the bonds will have an angle of 45° , the interatomic distances will be 1.5 times the default distance, the bonds will begin and end on the second atom of each group, and the bonds will be red and thick:

Default values

```
\chemfig{[1,1.5,2,2,red,thick]ABC-DEF=GHI}
```

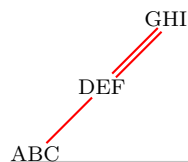

10 Branches

10.1 Principle

Up to now, all the molecules have been linear, which is rare. A sub-molecule can be attached to an atom by following the atom with *code* in parentheses. This *code* is the code of the sub-molecule which will be attached to the atom.

In this example, the sub-molecule “`-[1]W-X`” will be attached to atom “B”:

A branch

```
\chemfig{A-B(-[1]W-X)-C}
```

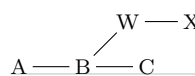

There can be several sub-molecules which are to be attached to the same atom. Just have several parentheses containing the code for each sub-molecule:

Multiple branches

```
\chemfig{A-B(-[1]W-X)(-[6]Y-[7]Z)-C}
```

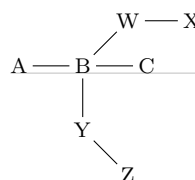

The code of each sub-molecule can define its own default values, which will be valid throughout the whole sub-molecule. Here a sub-molecule “`[:60]-D-E`” is attached to atom “B”, with a default angle of 60° absolute. A second sub-molecule “`[::-60,1.5]-X-Y`” is attached to “B” with a default bond angle 60° less than that of the preceding bond (which will be the one between “A” and “B”) and with an interatomic distance 1.5 times the default value:

Default values in branches

```
\chemfig{A-B[:60]-D-E)[::-60,1.5]-X-Y)-C}
```

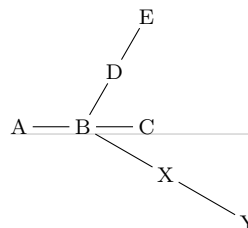

Observe what happens if, at the beginning of the main molecule, one writes “`[:-45]`”:

Effect of the default bond angle

```
\chemfig{[: -45]A-B([:60]-D-E)([: -30,1.5]-X-Y)-C}
```

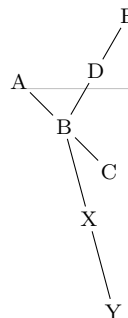

We see that the angle between the bond B-C and the bond B-X stays at 30° because it is a relative angle for the sub-molecule “-X-Y”. By contrast, the branch “-D-E” stays inclined at 60° to the horizontal, and does not follow the rotation given by the -45° angle at the beginning; this is expected because “-D-E” has an absolute angle. It is essential that all the angles be relative in order to rotate the whole molecule.

10.2 Nesting

Sub-molecules may be nested, and the rules seen in the preceding paragraphs stay in force:

Nested branches

```
\chemfig{A-B([1]-X([2]-Z)-Y)(-[7]D)-C}
```

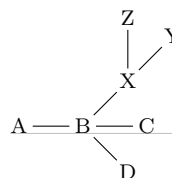

10.3 Method

Suppose now that we want to draw an acid anhydride molecule: R—C

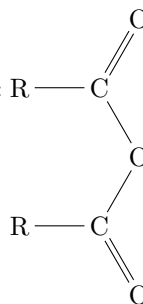

The best way to get this is to find the longest chain. Here, for example, we can draw the chain R-C-O-C-R taking into account angles and using only relative angles:

Acid anhydride structure

```
\chemfig{R-C-[: -60]O-[: -60]C-[: -60]R}
```

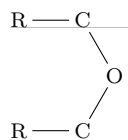

To this structure we just have to add two “=O” sub-molecules to each of the carbon atoms:

Acid anhydride

```
\chemfig{R-C(=[::+60]O)-[::-60]O-[::-60]C(=[::+60]O)-[::-60]R}
```

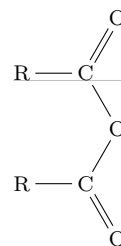

Because we used only relative angles, we can rotate this molecule by giving a default angle of e.g. 75°:

Rotation of a molecule

```
\chemfig{[:75]R-C(=[::+60]O)-[::-60]O-[::-60]C(=[::+60]O)-[::-60]R}
```

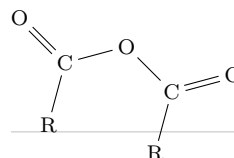

11 Connecting distant atoms

We have seen how to connect atoms *which are adjacent in the code*. It is often necessary to connect atoms which are not next to each other in the code. Let's call these particular bonds "distant bonds".

Let's take this molecule:

Branched structure

```
\chemfig{A-B(-[1]W-X)(-[7]Y-Z)-C}
```

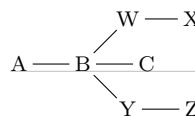

and suppose that we want to connect the atoms X and C. In this case, `chemfig` allows a "hook" to be placed *immediately* after the atom of interest. The character used for a hook is "?" because of its similarity to a hook. So, if one writes `X?` then the atom X will have a hook. Later in the code, all atoms followed by a ? will be connected to X:

Distant bond

```
\chemfig{A-B(-[1]W-X?)(-[7]Y-Z)-C?}
```

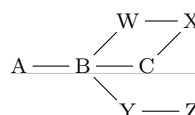

We could connect other atoms to X by following them with ?. Here it's the atoms C and Z:

Several distant bonds

```
\chemfig{A-B(-[1]W-X?)(-[7]Y-Z?)C?}
```

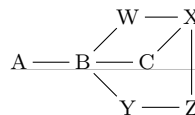

Now imagine if we were to leave the distant bonds X-C and X-Z while adding another: A-W. We must therefore ask for two *different* hooks, one on A and the other on X. Fortunately the character ? has an optional argument:

$$?[\langle name \rangle, \langle bond \rangle, \langle tikz \rangle]$$

where each field takes its default value if it is empty:

- The $\langle name \rangle$ is the name of the hook: all alphanumeric characters (a...z, A...Z, 0...9) are allowed⁴. The name is a by default. In the first occurrence of the hook with this name, only this field is used.

⁴This is not exactly right. Actually all the characters that can be put between `\csname...` and `\endsname` are allowed.

- `<bond>` specifies how the atom with the current occurrence of the named hook is to be bonded to the atom with the first occurrence of the hook. There are two ways this can be done. First, this field can be an integer representing the desired bond type: 1=single bond, 2=double bond, etc. (See the table on page 7 for the bond codes.)
Second, the field can be one of the bond character codes, provided that this character is *between braces*.
- `<tikz>` will be passed directly to `tikz` as we have seen with regular bonds.

Here is our molecule with the required distant bonds, then with the bond A-W and X-C customized:

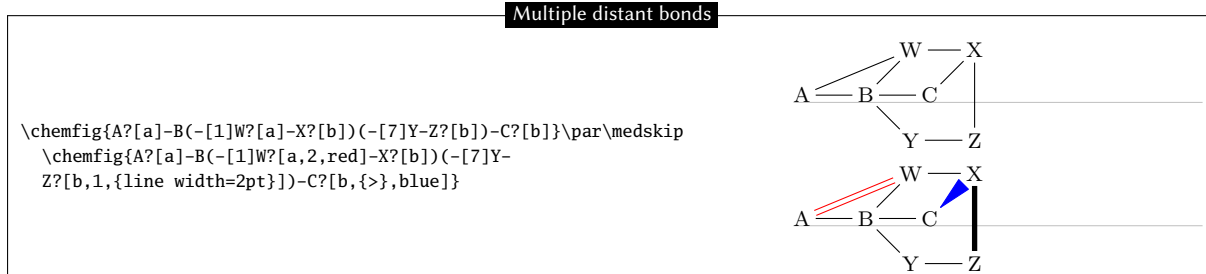

Several different hooks can be written after an atom. Suppose that in this unfinished pentagon, we wish to connect A-E, A-C and E-C:

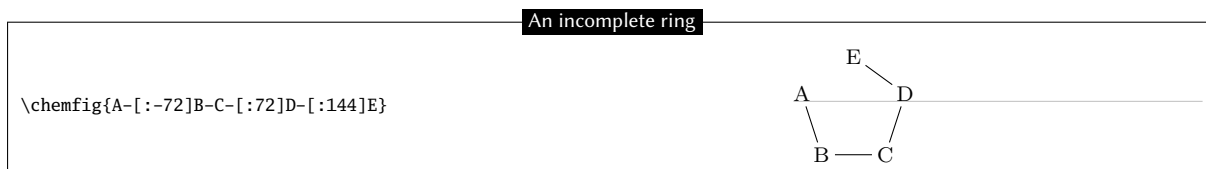

Then we must do this:

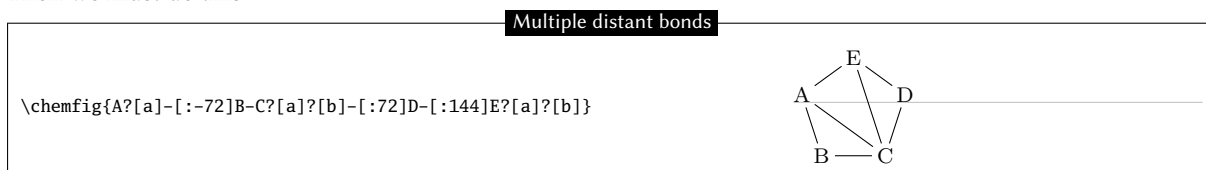

12 Rings

The preceding example shows how to draw a regular polygon, but the method used is tedious because the angles depend on the number of sides of the polygon.

12.1 Syntax

`chemfig` can easily draw regular polygons. The idea is to attach a ring to an `<atom>` outside the ring with this syntax:

$$\langle atom \rangle * \langle n \rangle (\langle code \rangle)$$

`<n>` is the number of sides of the polygon and the `<code>` describes the bonds and groups of atoms which make up its edges and vertices. This code *must* begin with a bond because the atom is outside the ring.

Here is a 5-ring, attached to the atom “A”:

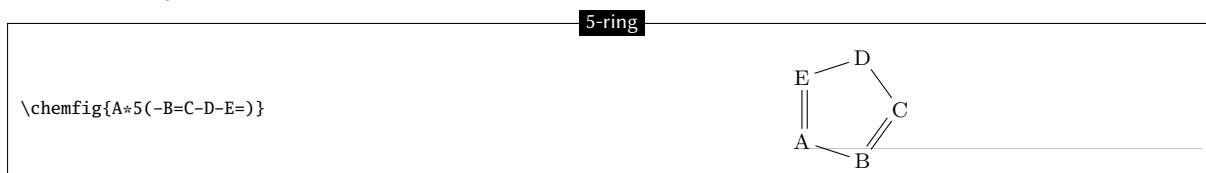

A ring can also be drawn with one, several, or all the groups of atoms empty, as is the case for diagrams outside rings:

5-ring with empty groups

```
\chemfig{*5(-----)}
```

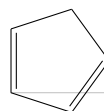

A ring can be incomplete:

Incomplete 5-ring

```
\chemfig{*5(-B=C-D)}
```

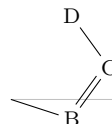

If a ring has a code which contains too many bonds and atom groups for the given number of vertices, all the bonds and groups over the maximum allowed are ignored:

Truncated 5-ring

```
\chemfig{A*5(-B=C-D-E=F-G=H-I)}
```

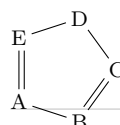

It is possible to draw a circle or an arc in the inside of a ring. To do so, the following syntax is used:

$$\langle atom \rangle^{**}[\langle angle 1 \rangle, \langle angle 2 \rangle, \langle tikz \rangle](n)(\langle code \rangle)$$

where each field of the optional argument takes its default value if it is empty:

- $\langle angle 1 \rangle$ and $\langle angle 2 \rangle$ are the absolute angles of the start and finish of the arc. These default to 0° and 360° respectively so that a circle is drawn by default;
- $\langle tikz \rangle$ is the code that will be passed to `tikz` for drawing the arc.

Rings and arcs

```
\chemfig{**6(-----)}\quad
\chemfig{**[30,330]5(-----)}\quad
\chemfig{**[0,270,dash pattern=on 2pt off 2pt]4(-----)}
```

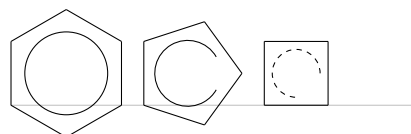

12.2 Angular position

12.2.1 At the start

As can be seen in the examples above, the rule is that the attachment atom “A” is always at the south-west of the ring. Furthermore, the ring is always constructed counterclockwise, and the last bond descends vertically onto the attachment atom:

Angular position of rings

```
\chemfig{A*4(-B-C-D-)}\quad\chemfig{A*6(-----)}
```

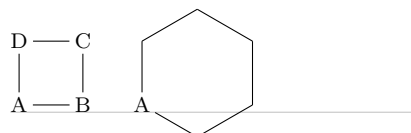

If this angular position is not convenient, it is possible to specify another angle using the optional argument at the beginning of the molecule. Here is a 6-cycle which has been rotated by $+30^\circ$, by -30° , and lastly by $+60^\circ$:

Rotation of rings

```
\chemfig{[:30]A*6(-----)}\quad
\chemfig{[:-30]A*6(-----)}\quad
\chemfig{[:60]A*6(-----)}
```

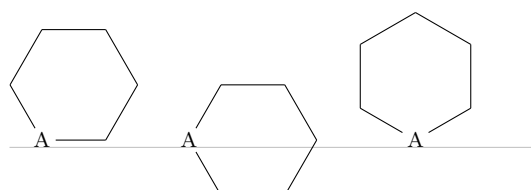

12.2.2 After a bond

When a ring does not begin a molecule and one or more bonds have already been drawn, the default angular position changes: the ring is drawn in such a way that the bond ending on the attachment atom bisects the angle formed by the first and last sides of the ring.

Here is a simple case:

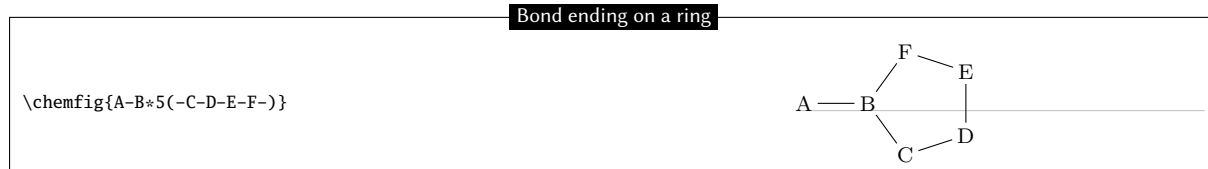

The rule remains valid, whatever the angle of the preceding bond:

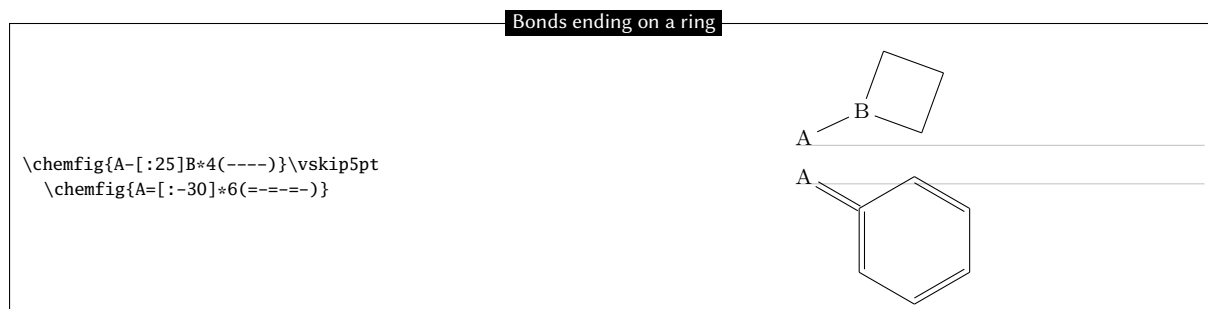

12.3 Branches on a ring

To have branches attached to the vertices of a ring, we use the syntax we have already seen:

$\langle atom \rangle (\langle code \rangle)$

where the $\langle code \rangle$ is that of the sub-molecule and the $\langle atom \rangle$ is at the vertex. Unique to rings, the default angle of the sub-molecule is not 0° but is calculated so that it will bisect the sides leaving the vertex:

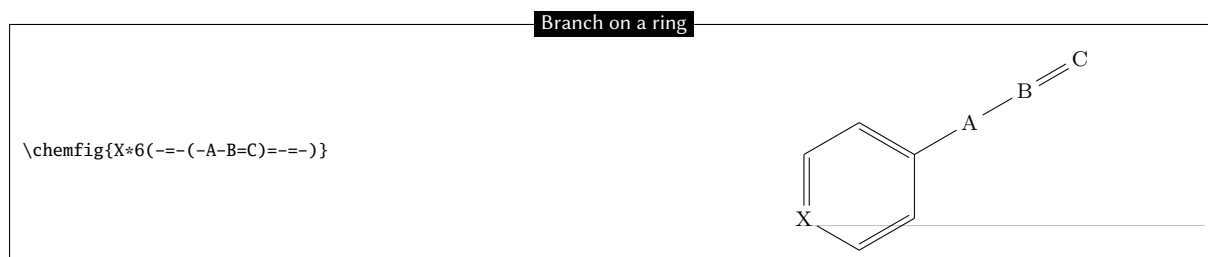

A sub-molecule can be attached to the first vertex of a ring, just like the other vertices:

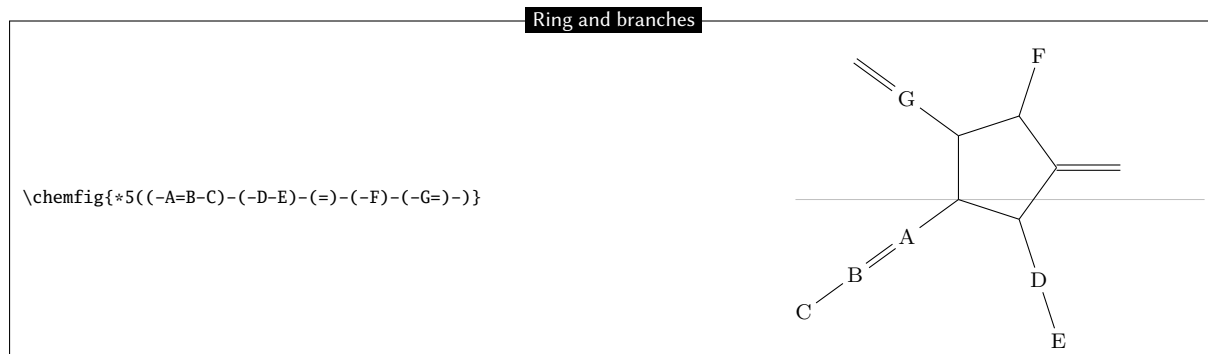

If one wants the bond leaving a vertex not to be the bisector of its sides, one can tinker with the optional global parameter or the optional bond parameter:

Branches at specified angles

```
\chemfig{*5(---([:90]-A-B---)}\quad
\chemfig{*5(---(-[:90]A-B---)}\quad
\chemfig{*5(---([::+0]-A-B---)}
```

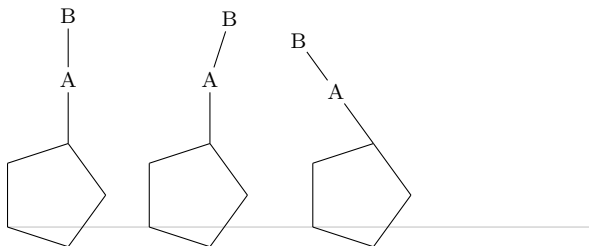

It is worth noting that in the third example, where a relative angle of 0° was given, the bonds of the branch are drawn in line with the preceding bond in the ring. This is the rule on page 10 which specified that the reference angle was that of the bond last drawn.

We can now connect together rings with bonds:

Connected rings

```
\chemfig{*6(--(*5(----(*4(----)))-)----)}
```

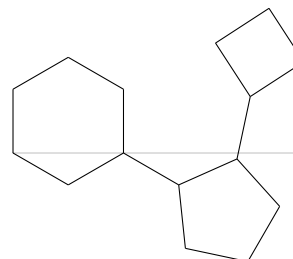

12.4 Nested rings

To “glue” two rings together, the syntax is only slightly different: the vertex is specified where the other ring is going to start. Simply follow this vertex by the usual syntax for a ring. Here for example is a 5-ring which is attached to the second vertex of a 6-ring:

Nested rings

```
\chemfig{A*6(-B*5(----)=---)}
```

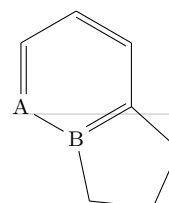

Note that the ring which is going to be attached to the main ring has an angular position such that two of the rings' sides coincide. In addition, the 5-ring has only four bonds “----”. In effect, the fifth will be useless because it is the second side of the 6-ring, which has already been drawn.

It is quite possible to glue multiple rings together:

Multiple nested rings

```
\chemfig{*5(--*6(-*4(*5(----))---)----)}
```

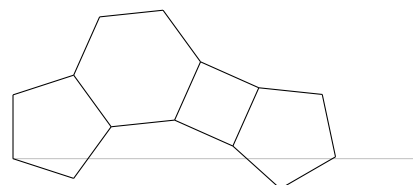

There is a case where a trick must be used. It can be seen in this example that the fourth side of the second 5-ring just passes through the center of atom “E”.

Flawed drawing

```
\chemfig{A-B*5(-C-D*5(-X-Y-Z)-E-F-)}
```

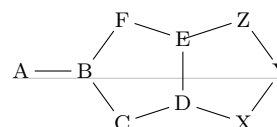

This is normal because the second 5-ring (which is attached to atom “D”) is drawn *before* chemfig knows about atom “E”. In this case, it is necessary to use two hooks to draw the bond Z-E:

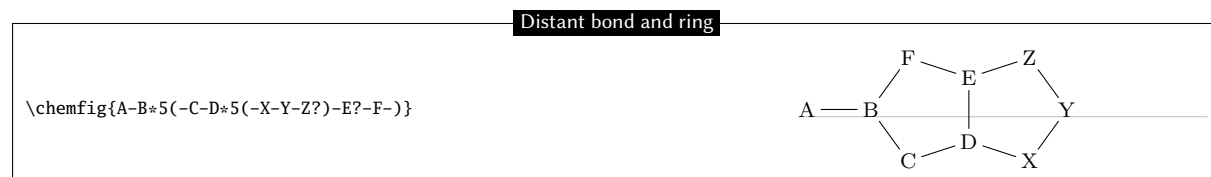

We could also use a `` at the last vertex of the 5-ring:

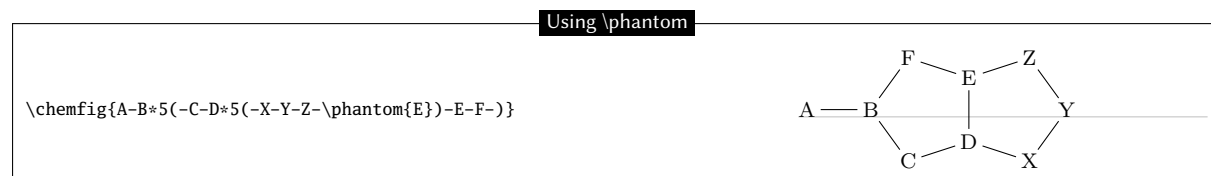

12.5 Rings and groups of atoms

Some care must be taken with rings when one or more vertices are made up of groups of atoms:

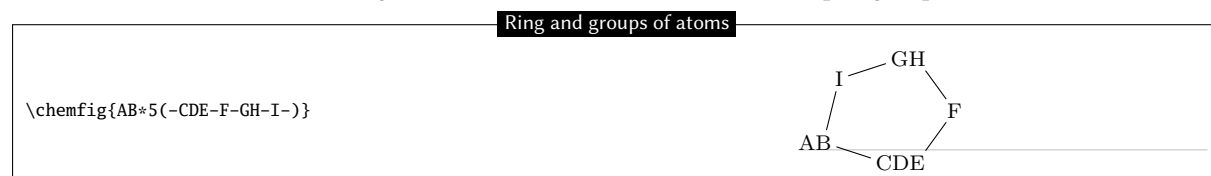

In order for the ring to have a regular shape, it is necessary to override the chemfig mechanism which automatically calculates the departure and arrival atoms of bonds. Here, C-F and F-G must be connected by using the optional argument of these bonds:

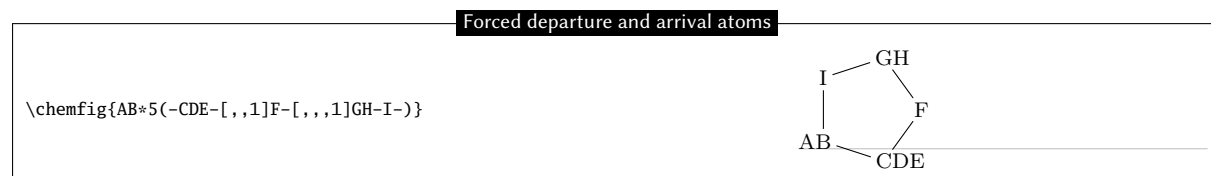

13 Representing electron movements

Starting with chemfig version 0.3, we can represent the movement of electrons in mesomeric effects or reaction mechanisms. This is done by marking the departure and arrival points of the electron movement arrow using the syntax “`@{<argument>}`”. This syntax allows a tikz node to be placed and makes this node accessible outside the argument of the `\chemfig` command thanks to the “remember picture” option which is passed to all the “tikzpicture” environments. It is assumed that the viewer supports “picture remembering” and that the compilation is done twice.

Two types of diagrams can arise, so we can ask for:

- a zero size node on a bond using the syntax “`@{<name>, <coeff>}`” placed at the beginning of the optional argument of the relevant bond, without being followed by a comma if there is a first optional argument. In this case, the node takes the name “`<name>`” and the `<coeff>`, which must be between 0 and 1, determines where the node is located on the bond. If “`@{<name>}`” is used, the `<coeff>` is set to 0.5 by default, which means that the node is placed halfway along the bond;
- a node on an atom using the syntax “`@{<name>}`” immediately before the relevant atom. In this case, the node has exactly the same footprint as the atom, but may be empty and therefore have zero dimensions.

Once the `\chemfig` command has drawn the molecule(s) and has placed the nodes with the syntax described above, we can connect these nodes to each other with `tikz` instructions. These instructions are placed in the argument of the command `\chemmove`⁵ and has the following syntax if (for example) we need to connect a node named “`<name1>`” to the node named “`<name2>`”:

```
\chemmove[<opt>]{\draw[<tikz opt>](<name1>)<tikz link>(<name2>);}
```

The optional argument `<opt>` of the `\chemmove` command will be added to the argument of the `tikzpicture` environment in which the links between the nodes will be drawn. The `<tikz opt>` and `<tikz link>` instructions are describe in detail in the documentation of the `tikz` package.

13.1 Mesomeric effects

To make these concepts concrete, let’s take the example of a mesomeric effect involving a double bond and non-bonding lone pair conjugate. Let’s begin with the possible delocalization of electrons from the double bond. We will place a node named “`db`” (double bond) in the middle of the double bond and a node named “`a1`” on the end of the double bond.

The macros `\schemestart`, `\schemestop`, `\arrow` and `\+` are explained in the chapter IV, starting on page 47.

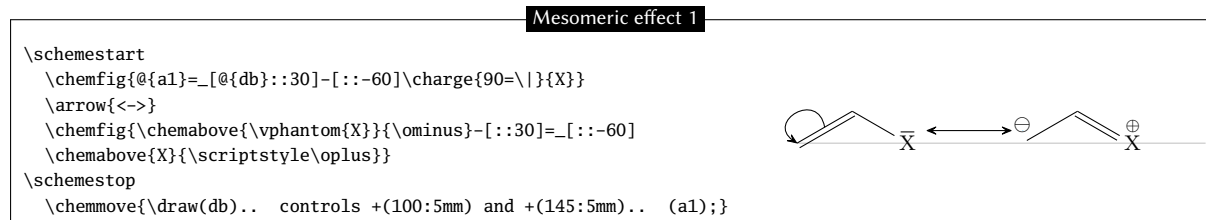

As noted above, there is no comma after the node placed in the optional arguments of a bond; we write “`=_[@{db}::30]`” and not “`=_[@{db}, ::30]`” as one might be tempted to do.

To link the nodes “`db`” and “`a1`” we have used the following syntax:

```
\chemmove{\draw(db)..controls +(80:8mm) and +(145:8mm)..(a1);}
```

For arrows in `\chemmove`, the default tip is “`CF`”. In this example we ask for an arrow (`[<->]`) and we use two `control points`⁶. These will be located using polar coordinates at 80° and 8 mm from “`db`” for the first and at 145° and 8 mm from “`a1`” for the second. Though this syntax may seem complicated at first reading, one need not be alarmed because its use will usually be a matter of copying and pasting. Only the names and coordinates of the control points need be changed, as can be verified from the example below, where an arrow has been added from the lone pair (node “`dn1`” to the single bond (node “`sb`”).

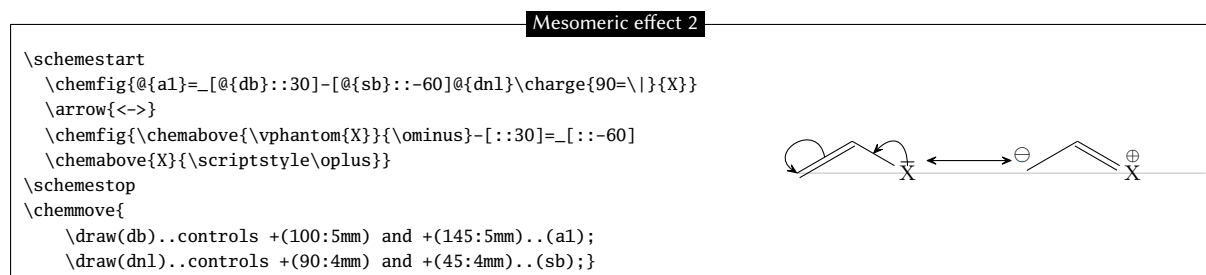

For our new arrow we have set the `control points` as follows: 4 mm at an angle of 90° from “`dn1`” and 4 mm at an angle of 45° from “`sb`”. But we are not completely satisfied, since we would like the arrow not to touch the line segment representing the lone pair. To do this we will add some options to our arrow.

⁵Actually, the `\chemmove` command puts its argument in a “`tikzpicture`” environment with the options “`remember picture, overlay`”.

⁶To find all the ways of connecting two nodes with `tikz`, read the documentation for that package.

Mesomeric effect 3

```
\schemestart
\chemfig{@{a1}=_[@{db}::30]-[@{sb}::-60]@{dn1}\charge{90=\}|{X}}
\arrow{<->}
\chemfig{\chemabove{\vphantom{X}}{\ominus}-[:30]=_[::-60]
\chemabove{X}{\scriptstyle\oplus}}
\schemestop
\chemmove[->]{% change the tip style
\draw(db).. controls +(100:5mm) and +(145:5mm).. (a1);
\draw[shorten <=3pt,shorten >=1pt](dn1) .. controls +(90:4mm)
and +(45:4mm) .. (sb);}
```

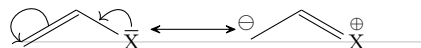

The option “shorten <=3pt” indicates that the tail of the arrow is to be shortened by 3 pt just as “shorten >=2pt” means that the head of the arrow is shortened by 2 pt.

We can use all the power of `tikz` instructions to modify the style of the arrow. Here we change the head of the arrow leaving the double bound and set it to “-stealth”, and we draw the arrow with a fine dashed red line. We also add the letter π above the middle of the arrow:

Mesomeric effect 4

```
\schemestart
\chemfig{@{a1}=_[@{db}::30]-[@{sb}::-60]@{dn1}\charge{90=\}|{X}}
\arrow{<->}
\chemfig{\chemabove{\vphantom{X}}{\ominus}-[:30]=_[::-60]
\chemabove{X}{\scriptstyle\oplus}}
\schemestop
\chemmove{
\draw[-stealth,thin,dash pattern= on 2pt off 2pt,red]
(db).. controls +(100:5mm) and +(145:5mm)..
node[sloped,above] {$\pi$} (a1);
\draw[shorten <=3pt, shorten >= 1pt]
(dn1).. controls +(90:4mm) and +(45:4mm).. (sb);}
```

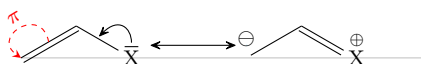

In the following example, we'll see how to indicate the position of the departure or arrival anchor points of the arrow. If we write

Departure or arrival anchor point 1

```
\chemfig{@{x1}\charge{45=\}|{X}}
\hspace{2cm}
\chemfig{@{x2}\charge{90=\}|{X}}
\chemmove{
\draw[shorten >=4pt](x1).. controls +(90:1cm) and +(90:1cm).. (x2);}
```

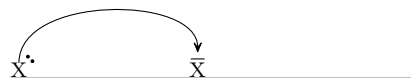

Note that the tail of the arrow does not leave correctly from our electrons; it leaves from the middle of the upper edge of the node. Indeed, we chose a departure angle of 90° and so `tikz` makes the arrow leave from the anchor “x1.90” which corresponds to the intersection of the ray leaving from the center of node “x1” at a 90° angle relative to the horizontal and of the edge of the rectangular node. To get the arrow departure angle that we want, we must specify its position. After some trial and error, it is “x1.57”:

Departure or arrival anchor point 2

```
\chemfig{@{x1}\charge{45=\}|{X}}
\hspace{2cm}
\chemfig{@{x2}\charge{90=\}|{X}}
\chemmove[shorten <=4pt,shorten >=4pt]{
\draw(x1.57).. controls +(60:1cm) and +(120:1cm).. (x2.90);}
```

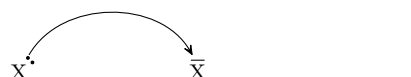

In some cases it will be easier to use Cartesian coordinated for the control points. Here we use just one control point placed 1 cm to the right of and 1.5 cm above “x1”:

A single control point

```
\chemfig{@{x1}\charge{45=\}|{X}}
\hspace{2cm}
\chemfig{@{x2}\charge{90=\}|{X}}
\chemmove[shorten <=4pt,shorten >=4pt]{
\draw(x1.57).. controls +(1cm,.8cm).. (x2.90);}
```

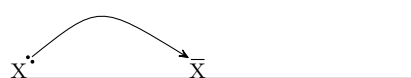

All the graphics drawn by means of the command `\chemmove` are superimposed and will not be included in the bounding boxes. We can see this in the preceding example.

13.2 Reaction mechanisms

Thanks to the option `remember picture` which is passed to all the “tikzpicture” environments we can easily draw arrows indicating reaction mechanisms. Let’s take for example the first step of the esterification reaction.

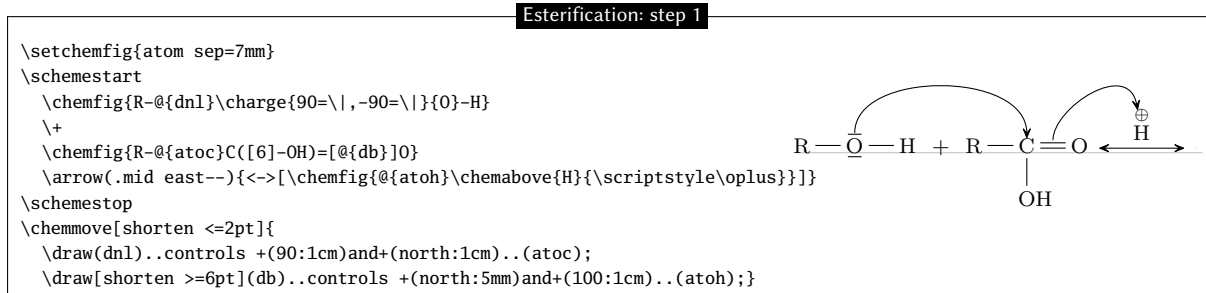

The use of the `\chemabove{<code>}{<material>}` command does not change the dimensions of the bounding box of `<code>`. For this reason we can run into some difficulty in pointing to the symbol representing the charge carried (\oplus or \ominus). In the example above the solution is to create a control point with an angle of 110° at 1 cm from “atoh” and to shorten the arrow by 6pt. In the following example, the second step of the esterification reaction, we can see that the arrow can take more complicated forms without complicating the code.

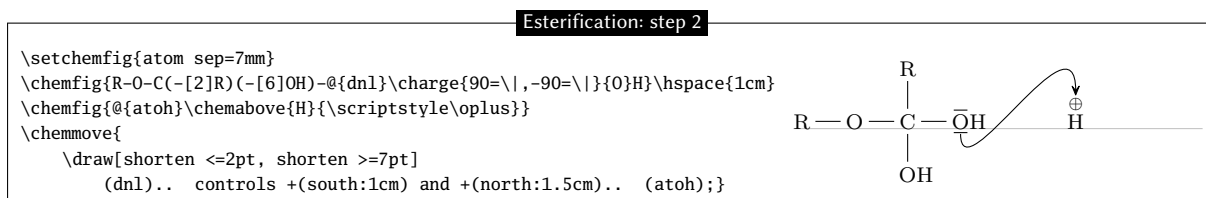

The rest is left as an exercise to the reader...

14 Writing a name under a molecule

For convenience, `chemfig` can write the name of a molecule underneath it with the command

$$\backslash\chemname[<dim>]{\chemfig{\langle code\ of\ the\ molecule\rangle}}{\langle name\rangle}$$

The `<dim>`, which is 1.5ex by default, will be inserted between the baseline of the molecule and the top of the letters of the `<name>`. The `<name>` will be centered relative to the molecule, but the `<name>` may not contain multiple paragraphs. As we see in this example: H — O — H, the `<name>` which is displayed under the molecule is

The water molecule: H₂O

taken into account only for the vertical size of the bounding box. The horizontal size of `<name>` is always zero.

Here is a reaction with the names under the molecules:

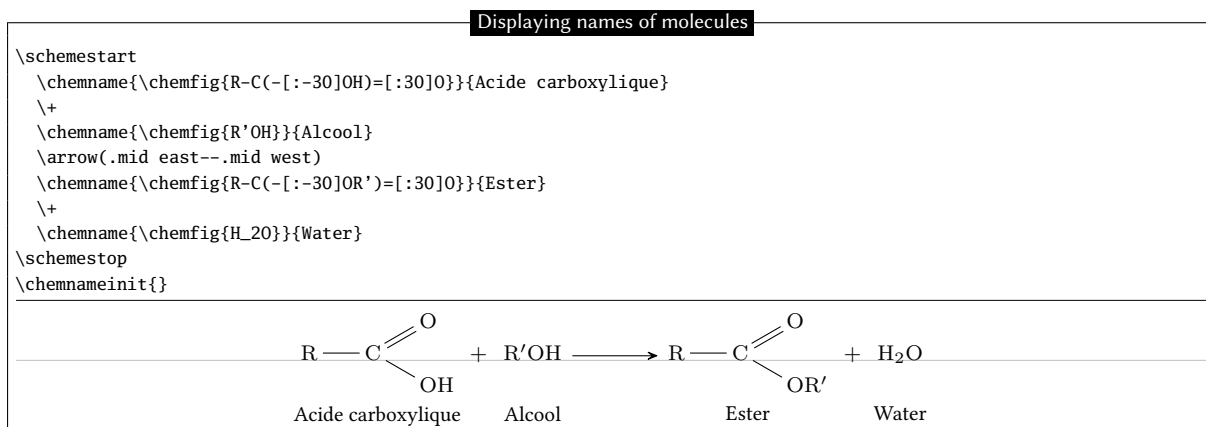

There are some limitations to this command. Suppose we switch the acid and the alcohol on the left side:

Name alignment 1

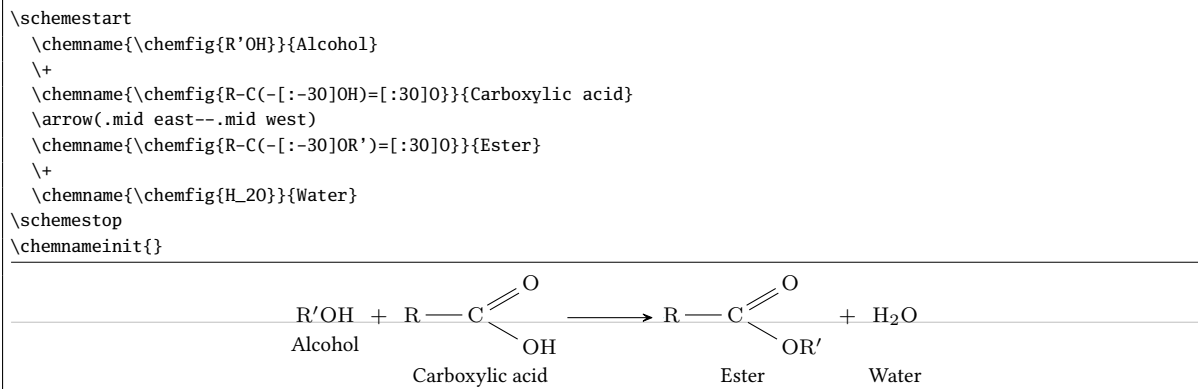

In fact, to draw the $\langle name \rangle$ the command `\chemname` inserts $1.5ex + \textit{the largest of the depths}^7$ of the molecules *thus far* below the baseline of each molecule (light gray for the examples in this manual). The command `\chemnameinit{\langle stuff \rangle}` initializes this largest depth with the $\langle stuff \rangle$. Therefore one should:

- write `\chemnameinit{\langle deepest molecule \rangle}` before using the `\chemname` command in a reaction, unless the reaction begins with the deepest molecule;
- write `\chemnameinit{}` after having written all the names in a chemical reaction lest the greatest depth in this reaction interfere with a future reaction.

Thus the correct code uses `\chemnameinit` before and after the reaction:

Name alignment 2

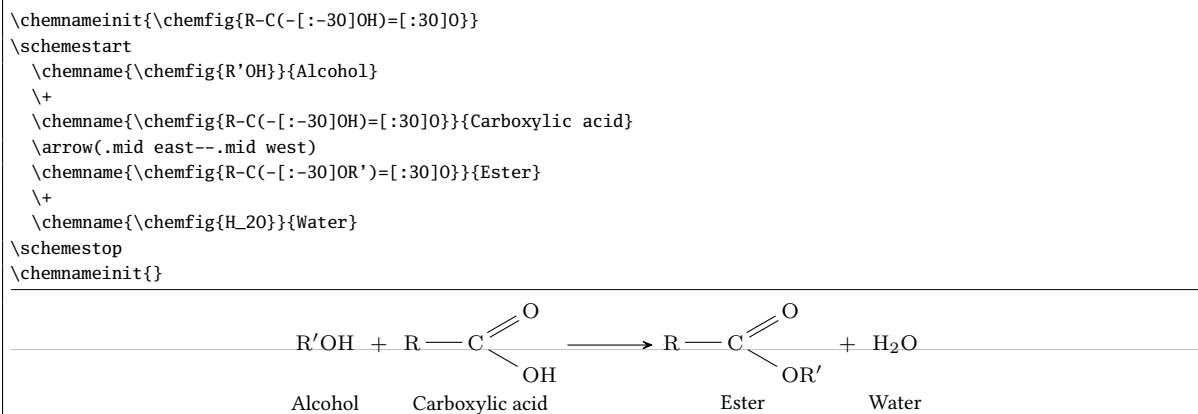

Finally, to write a name on multiple lines, the command `\` encountered in a $\langle name \rangle$ causes a line break⁸:

Name on 2 lines

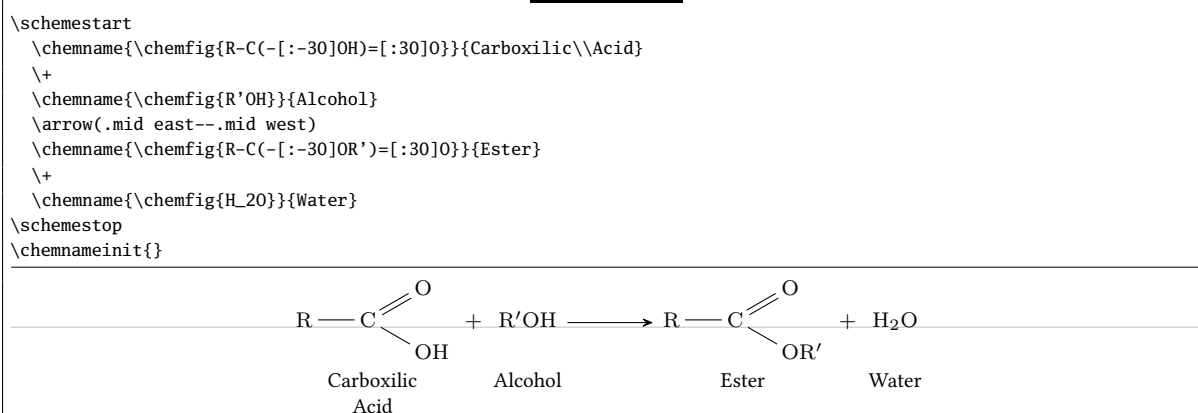

If `\chemname*{\langle name \rangle}` is written, the macro does not take into account the previous names.

⁷In T_EX terms, the depth is the dimension which extends vertically below the baseline.

⁸Conversely, the command `\par` is forbidden and causes a compilation error.

Advanced usage

1 Separating atoms

The `separating atom` mechanism described previously extends each atom until the next capital letter or one of the characters `{}|[]{}@`.

In certain cases this automatic separation produces incorrect atoms which can translate into an imperfect diagram. Consider this example molecule, noting that the “(” character is placed between braces so that `chemfig` doesn't incorrectly create a branch:

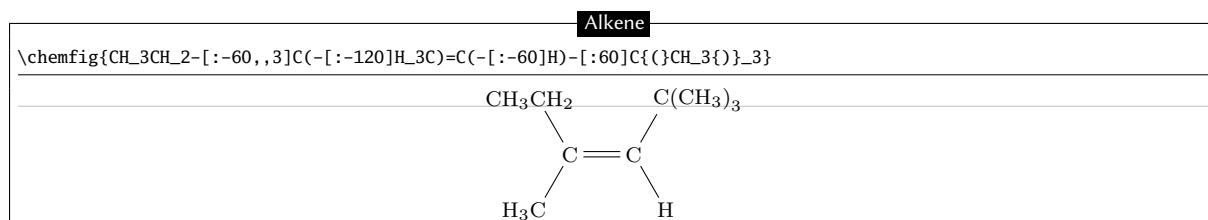

We find that the bond which arrives at the carbon atom in the upper right is too short. This happens because, if we apply the `chemfig` rules for separating atoms to the upper right group, the atoms are split in this way: “C{()”, “C”, “H_3{}}_3”. We now realize that the first atom contains a parenthesis and thus has too great a depth in math mode; we can see this by making the bounding boxes visible:

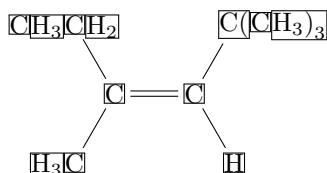

The character “|” forces splitting of the atom when it is encountered. Thus we can write `C|(CH_3)_3` to ensure that `chemfig` separates just two atoms here: “C” and “{(CH_3)_3}”. The problem of the too-short bond is thus solved:

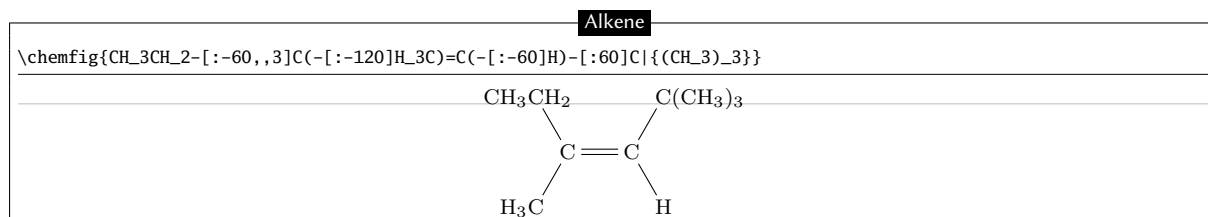

2 Displaying atoms

Once a molecule has been split into atoms, the macro `\printatom` is called internally by `chemfig` in order to display each atom. Its sole argument is the code of the atom to be displayed (e.g. “H_3”). By default, this macro enters math mode and displays its argument with the math font family “rm”. It is defined by the following code:

- `\newcommand*\printatom[1]{\ensuremath{\mathrm{#1}}}` when compiling with \LaTeX
- `\def\printatom#1{\ifmmode\rm#1\else$\rm#1$\fi}` when compiling with $\epsilon\TeX$ ou \ConTeXtX .

One can modify the code of this macro to customize how atoms are displayed. In the following example, we redefine `\printatom` so that each atom will be enclosed in a rectangular box:

Redefinition of \printatom

```
\fboxsep=1pt
\renewcommand*\printatom[1]{\fbox{\ensuremath{\mathrm{#1}}}}
\chemfig{H_3C-C(=[:30]O)(-[:-30]OH)}
```

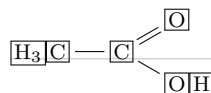

Here is how to redefine it to use the “sf” font family of math mode:

Atoms displayed with “sf” font family

```
\renewcommand*\printatom[1]{\ensuremath{\mathsf{#1}}}}
\chemfig{H_3C-C(=[:30]O)(-[:-30]OH)}
```

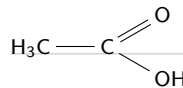

3 Arguments given to tikz

The *key* `chemfig style` contains tikz instructions which will be passed to the tikzpicture environment in which the molecule is drawn. On the other hand, the *key* `atom style` contains tikz instructions which will be executed when each node; these instructions are added to the end of every node/.style{<argument>}, i.e. after the following instructions: “anchor=base, inner sep=0pt, outer sep=0pt, minimum size=0pt”.

With the use of the first optional argument one can, for example, choose the global color or thickness of lines:

Style choice

```
\chemfig{A-B-[2]C}\par\medskip
\setchemfig{chemfig style={line width=1.5pt}}\chemfig{A-B-[2]C}\par\medskip
\setchemfig{chemfig style=red}\chemfig{A-B-[2]C}
```

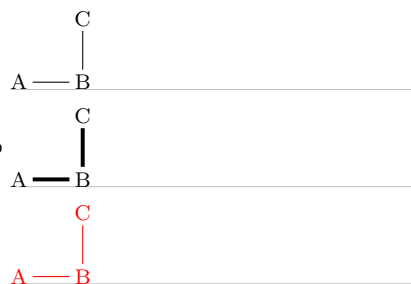

With `node style`, one can choose the colour of nodes drawn by tikz, change the angle of the drawing or its scale:

Style choices

```
\chemfig{A-B-[2]C}\par\medskip
\setchemfig{atom style=red}\chemfig{A-B-[2]C}\par\medskip
\setchemfig{atom style={rotate=20}}\chemfig{A-B-[2]C}\par\medskip
\setchemfig{atom style={scale=0.5}}\chemfig{A-B-[2]C}
```

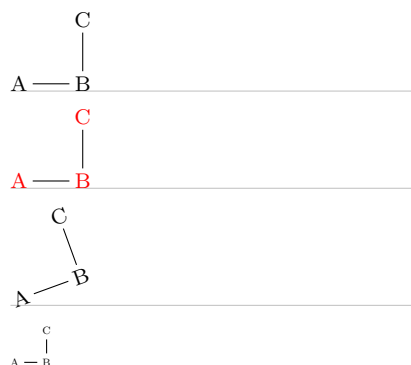

4 Shifted double bonds

All double bonds are made up of two line segments, and these segments are drawn on either side of the imaginary line along which a single bond would be drawn. It is possible to shift a double bond so that one of the line segments lies on the imaginary line. The other segment is then shifted above or below the bond. Actually, it is more correct to say “left” or “right” of the imaginary line, as the bond is traversed in the direction of drawing.

To shift the bond to the left, write “=^” and to shift it to the right, write “=_”:

Shifted double bonds

```
\chemfig{A==B}\par
\chemfig{A^^B}\par
\chemfig{A=-B}
```

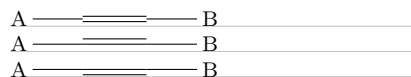

In rings, double bonds are automatically shifted to the left. However, they can be shifted to the right by specifying it with “=”:

Shifted double bonds and rings

```
\chemfig{*6(====)}\quad
\chemfig{*6(==_==_)}\quad
```

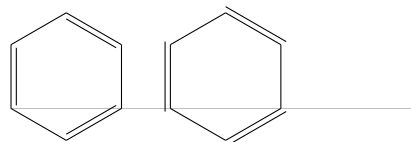

Shifted bonds are particularly useful in drawing skeleton diagrams of molecules consisting of carbon chains with double bonds. They give a continuous zig-zag path, whereas the path will be broken with regular double bonds:

Shifted bonds and skeleton diagrams

```
\chemfig{-[:30]=[:30]-[:30]=[:30]-[:30]=[:30]}\par
\chemfig{-[:30]=^[:30]-[:30]=^[:30]=^[:30]-[:30]}\par
\chemfig{-[:30]=_[:30]-[:30]=_[:30]-[:30]=_[:30]}\par
```



5 Delocalized double bonds

It is sometimes necessary to draw a double bond so that one line would be full and the other dashed. This feature is not hard-coded in chemfig since tikz, with its “decorations.markings” library makes it possible.

Delocalized bonds

```
\catcode'\_ =11
\tikzset{
  ddbond/.style args={#1}{
    draw=none,
    decoration={%
      markings,
      mark=at position 0 with {
        \coordinate (CF@startdeloc) at (0,\dimexpr#1\CF_doublesep/2)
        coordinate (CF@startaxis) at (0,\dimexpr-#1\CF_doublesep/2);
      },
      mark=at position 1 with {
        \coordinate (CF@enddeloc) at (0,\dimexpr#1\CF_doublesep/2)
        coordinate (CF@endaxis) at (0,\dimexpr-#1\CF_doublesep/2);
        \draw[dash pattern=on 2pt off 1.5pt] (CF@startdeloc)--(CF@enddeloc);
        \draw (CF@startaxis)--(CF@endaxis);
      }
    },
    postaction={decorate}
  }
}
\catcode'\_ =8
\chemfig{A-[,,,ddbond={+}]B-[,,,ddbond={-}]C}
```



6 Saving a sub-molecule

chemfig is capable of saving a $\langle code \rangle$ as an alias for reuse in a more compact form in the code of a molecule. This is particularly useful when the $\langle code \rangle$ appears several times.

To do this, one gives the command

```
\definesubmol{<name>}{<code>}
```

which saves the $\langle code \rangle$ for recall in the code of the molecule via the shortcut “! $\langle name \rangle$ ”. This $\langle name \rangle$ can be:

- a sequence of characters: all the alphanumeric characters able to be between $\backslash csname$ and $\backslash endsname$ are accepted;
- a control sequence.

In all cases, if the alias is already defined you should not overwrite it with a new definition using $\backslash definesubmol$. A warning will be issued to the user that the old alias will be overwritten by the new one. To override the definition of an alias made previously, use:

$$\backslash redefinesubmol\{\langle name \rangle\}\{\langle code \rangle\}$$

Here is a code which draws the pentane molecule. An alias “xy” was defined beforehand for the code CH₂:

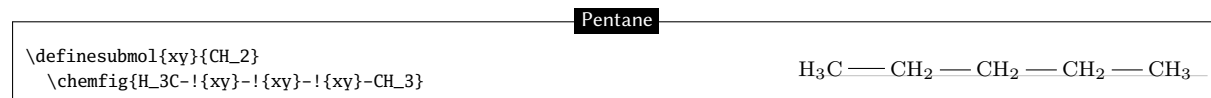

In this case the technique is not very interesting because “! $\langle xy \rangle$ ” is just as long to type as the code it replaces.

But in certain cases, this feature saves a lot of space in the code of the molecule and increases readability. In the following example, we draw the complete structural diagram of butane. We will define an alias with the control sequence “ $\backslash xx$ ” for the sub-molecule CH₂. If we use only relative angles, it is possible to rotate the entire molecule to any given angle by using the optional global angle parameter which specifies the default bond angle of the main molecule. It is set to 15° here:

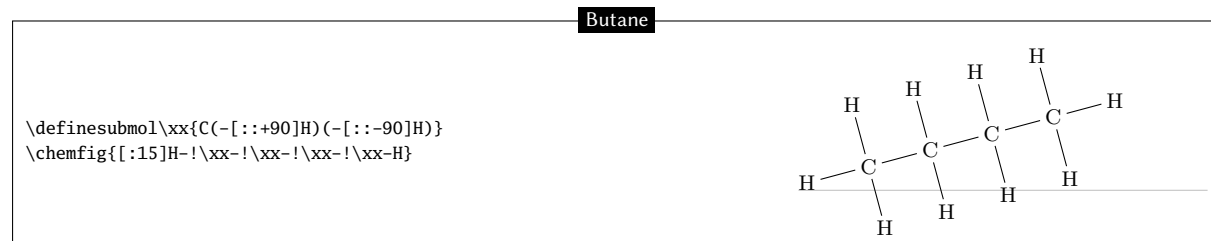

The $\backslash definesubmol$ command takes an optional argument; its syntax is as follows:

$$\backslash definesubmol\{\langle name \rangle\}[\langle code1 \rangle]\{\langle code2 \rangle\}$$

When the optional argument is present, the alias “! $\langle name \rangle$ ” will be replaced by $\langle code1 \rangle$ if the bond which arrives at the alias comes from the right, i.e., if the angle which the arriving bond makes is between but is not equal to 90° and 270°. For all the other cases where the bond arrives from the left of vertically, the alias will be replaced by $\langle code2 \rangle$.

We will define a control sequence $\backslash Me$ pour “methyl” so that the alias “! $\backslash Me$ ” will be replaced by “H₃C” when the bond arrives from the right and by “CH₃” when it arrives from the left. We can observe in the example that with this alias we need no longer worry about the angle:

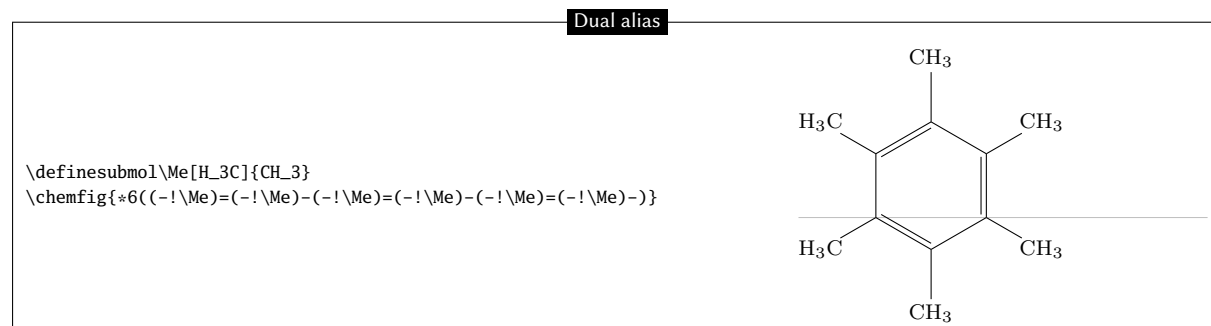

The sub-molecule saved with a $\langle name \rangle$ does not admit an argument when it is called after “!”. To define a sub-molecule admitting one or more arguments, place this $\langle number \rangle$ of arguments just after the $\langle name \rangle$. And the full syntax of $\backslash definesubmol$ is:

$$\backslash definesubmol\{\langle name \rangle\}\langle number \rangle[\langle code1 \rangle]\{\langle code2 \rangle\}$$

In the $\langle codes \rangle$, the arguments must appear in their usual form “# $\langle n \rangle$ ” where $\langle n \rangle$ is the argument number.

`\definesubmol with arguments`

```
\definesubmol\X1[-,-0.2,,draw=none]{\scriptstyle#1}  
\chemfig{*6((!\X A)-(!\X B)-(!\X C)-(!\X D)-(!\X E)-(!\X F)-)}  
  
\definesubmol{foo}3[#3|\textcolor{#1}{#2}]{\textcolor{#1}{#2}|#3}  
\chemfig{A(-[:135]!\foo}{red}XY)-B(-[:45]!\foo}{green}{W}{zoo})}
```

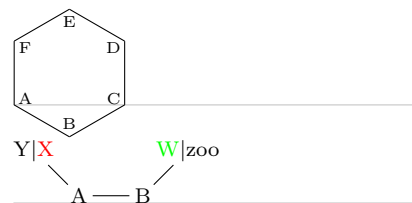

It should be noted that if the $\langle number \rangle$ of arguments is incorrect (negative or greater than 9), an error message will be issued and `chemfig` will consider that the sub molecule does not admit an argument.

Except in cases where the character `#` is followed by a number between 1 and $\langle number \rangle$ in which case it represents an argument, `#` are allowed in the sub-molecule codes.

`Use of #`

```
\definesubmol\X2{#1-#2-#3-#(3pt,3pt)#4}  
\chemfig{A-!\X{M}{N}-B}
```



In this example, only `#1` and `#2` are understood as the arguments of the sub molecule `\X`. The other `#` are displayed as they are in the molecule (case of `#3` and `#4`) or understood as the character specifying the fine adjustment of the offset of the bonds.

7 Placement of Atoms

7.1 First Atom

As explained on page ??, the first atom encountered (whether empty or not) is the one that is placed on the baseline, represented in gray on the examples of this manual. The choice of this first atom thus conditions the placement of all the others and often influences the placement of the whole molecule.

`First atom`

```
\chemfig{H-[7]C(-[5]H)=C(-[1]H)-[7]H}\quad  
\chemfig{C(-[3]H)(-[5]H)=C(-[1]H)-[7]H}
```

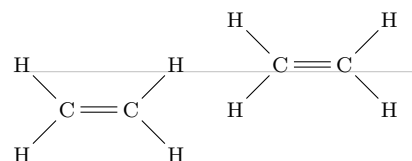

7.2 Groups of atoms

In a group of atoms, the atoms are placed one after the other in a well-established order:

- the first one which is placed (which we will call "reference atom") is the one on which the bond arrives; in the case of the beginning of the molecule, the atom on the left is the reference atom;
- the atoms to the right of the reference atom are then placed from left to right;
- atoms to the left of the reference atom are finally placed from right to left.

In the group of atoms thus formed, the baselines of each atom are on *the same horizontal line*, in other words, the atoms are all aligned on the same horizontal line.

In the example below whose code would be `\chemfig{A[: -60,, ,3]BCDEF}` the reference atom of the 2nd group of atoms is "D" because the bond is requested to arrive on the 3rd atom. Below each atom of this group is the sequence number in which the atom is displayed:



7.3 Bonds between atoms

A bond starting from an atom would, if extended, pass through the centre of its bounding box. The atom placed at the end of the bond has its center of its bounding box in the extension of the bond. Therefore, a bond between two atoms extends through the centers of their bounding boxes, as shown in this example:

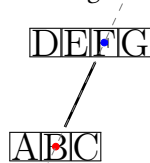

This mechanism can create misalignments between groups of atoms that are particularly visible when the bonds are horizontal. Everything works well when the atoms have the same vertical dimensions; however, if a departure atom is high (with exponent) or deep (with subscript) and the arrival atom has a different vertical dimension, the alignment is broken.

Horizontal alignment

```
\Huge\setchemfig{atom sep=2em}
\chemfig{A^1-B-C-D}\quad
\chemfig{E_1-F-G-H}
```



It is surprising that the second atom is correctly aligned when the last two are vertically shifted. This is because `chemfig` adds in front of each arrival atom the `\vphantom` of the departure atom, but without including it in the content of this arrival atom: this `\vphantom` is thus not intended to be reflected on the following atoms. This phenomenon can be shown by making visible the bounding boxes of the atoms where it appears that the atoms "B" and "F" have bounding boxes whose height takes into account the heights of the preceding atom:

Horizontal placement and bounding boxes

```
\Huge\setchemfig{atom sep=2em}
\fbboxsep=0pt
\renewcommand\printatom[1]{\fbox{\ensuremath{\mathrm{#1}}}}
\chemfig{A^1-B-C-D}\quad
\chemfig{E_1-F-G-H}
```



Since no automatic solution is satisfactory, we can manually get around this problem by creating a departure atom being a "strut" equal to `\vphantom{X}`: thus, the starting atom has a "normal" height and no shift will be reflected on the next group of atoms. A sub-molecule is used here for brevity.

Bypassing vertical placement

```
\Huge\setchemfig{atom sep=2em}
\definesubmol\I{\vphantom{X}}
\chemfig{A^1|\I-B-C-D}\quad
\chemfig{E_1|\I-F-G-H}
```



The disadvantage is that the first bond is too long because the departure atom now has a zero horizontal dimension.

If we are *really sure* to understand the consequences that this will have on the molecule and especially if it lends itself to it, we can redefine `\printatom` so that it forces the atom's bounding box to have fixed vertical dimensions; for example that of "X₁".

Redefinition of `\printatom`

```
\Huge\setchemfig{atom sep=2em}
\let\oldprintatom\printatom
\renewcommand\printatom[1]{%
  \begingroup
  \setbox0\hbox{\oldprintatom{X^1_1}}%
```

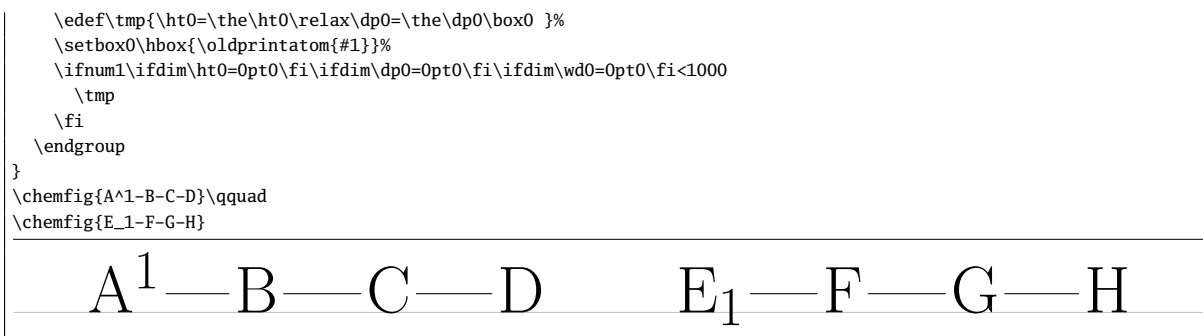

7.4 La macro `\chemskipalign`

For any group of atoms it is possible to temporarily deactivate the alignment adjustment mechanism and thus neutralize the `\vphantom`. Simply place the `\chemskipalign` command in the group of atoms; the alignment will resume in the following group of atoms as if the group of atoms containing `\chemskipalign` had never existed. The following example shows the effects of this instruction: the reference point of the box containing the first atom is placed at the level of the bond which arrives from the left. The bounding boxes of the atoms are drawn in the second line.

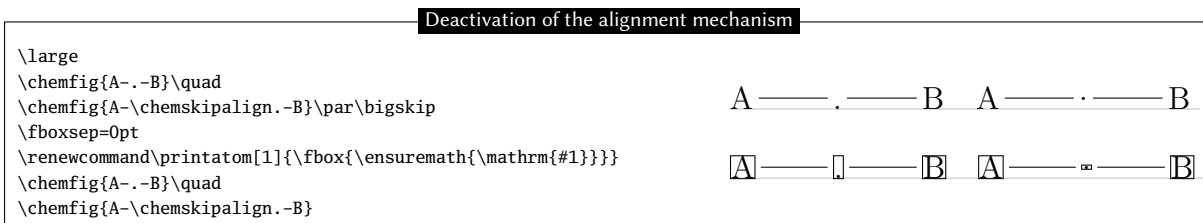

This command is to be used with caution lest the alignment of atoms in the next group be disrupted. In general, all will be well if the group of atoms featuring `\chemskipalign` contains a *single atom* whose height and depth are *less* than those of the preceding and following atoms, and if the preceding and following atoms have identical heights and depths. Here is an example of the mess that results when the group of atoms contains two atoms, here “`\chemskipalign.`” and “`B`”:

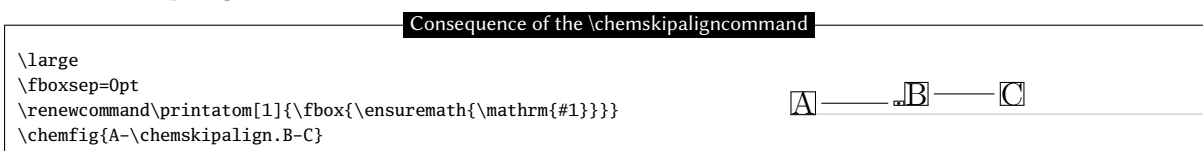

This feature can sometimes be useful. Suppose we want to draw the following molecule



We can define commands which will draw the empty and full disks with `tikz`. To ensure that these disks are at the right height, namely the height of the bond arriving at them, we will use the command `\chemskipalign`. In the second line below the bonds are “stuck” to the disks by using the ability to change the bond shortening with the “#” character, a feature seen on page 8.

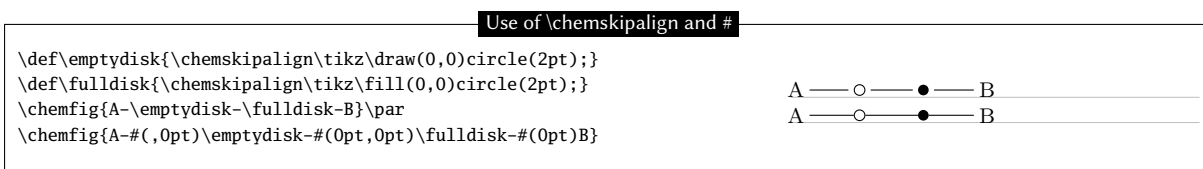

8 The macro `\charge`

8.1 Overview

The macro `\load`, which requires two mandatory arguments, allows to arrange elements (called $\langle charges \rangle$) around an $\langle atome \rangle$; its syntax is

$$\backslash\charge{[\langle general parameters \rangle]}(\langle position \rangle)[\langle tikz code \rangle]=\langle charge \rangle\{\langle atom \rangle\}$$

where:

- the $\langle atom \rangle$ is usually one or two letters, but it can also be empty;
- the $\langle charge \rangle$ is an arbitrary content that will be placed around the atom. Few constraints exist on this content: it can be text (in math mode if needed), or even `tikz` code or a molecule drawn with `chemfig`;
- the $\langle general parameters \rangle$ (optional) are a list of key/values specifying the options that this execution of the macro must satisfy. These keys/values are described below;
- the $\langle position \rangle$ is " $\langle angle \rangle:\langle shift \rangle$ ", but it is possible to specify only the $\langle angle \rangle$, in which case, the $\langle shift \rangle$ will be equal to 0pt;
- the optionnal $\langle tikz code \rangle$ sets the options given to the `tikz` macro `\node`, which places the $\langle charge \rangle$.

8.2 Parameters

The $\langle keys \rangle = \langle values \rangle$ available in the $\langle general parameters \rangle$ are:

$\langle keys \rangle$	default $\langle values \rangle$	Description
<code>debug</code>	false	boolean which, when $\langle true \rangle$, draws the outlines of the nodes receiving the $\langle atoms \rangle$ (in green), the $\langle loads \rangle$ (in blue) and the $\langle charge \rangle$ (in red).
<code>macro atom</code>	<code>\printatom</code>	macro receiving the $\langle atom \rangle$ as argument.
<code>circle</code>	false	boolean which, when $\langle true \rangle$, puts the $\langle atom \rangle$ in a circular node; otherwise, the node is rectangular.
<code>macro charge</code>	$\langle vide \rangle$	macro (e.g., <code>\printatom</code> or <code>\ensuremath</code>) receiving each charge as an argument.
<code>extra sep</code>	1.5pt	node size increment of the $\langle atom \rangle$ to put the $\langle charges \rangle$: it is the value passed to the <code>inner sep</code> of <code>tikz</code> .
<code>overlay</code>	true	boolean which, when $\langle true \rangle$, draws the $\langle charges \rangle$ "overlay", i.e. outside the final bounding box.
<code>shortcuts</code>	true	boolean which, when $\langle true \rangle$, activates the shortcuts " <code>\.</code> ", " <code>\:</code> ", " <code>\ </code> " and " <code>\</code> " to draw Lewis formulas.
<code>lewisautorot</code>	true	boolean which, when $\langle true \rangle$, automatically rotates " <code>\:</code> ", " <code>\ </code> " and " <code>\</code> ".
<code>.radius</code>	0.15ex	radius of the point used to plot " <code>\.</code> " and " <code>\:</code> ".
<code>:sep</code>	0.3em	separation between the two dots of " <code>\:</code> ".
<code>.style</code>	<code>fill=black</code>	<code>tikz</code> style used to draw the " <code>\.</code> " and " <code>\:</code> " dots.
<code>"length</code>	1.5ex	length of the rectangle " <code>\</code> " and the line " <code>\ </code> ".
<code>"width</code>	.3ex	width of the rectangle " <code>\</code> ".
<code>"style</code>	<code>black,line width=0.4pt</code>	<code>tikz</code> style used to draw the rectangle " <code>\</code> ".
<code> style</code>	<code>black,line width=0.4pt</code>	TIKZ style used to draw the line " <code>\ </code> ".

It is possible to set some (or all) of these parameters by running the macro

$$\backslash\setcharge{\langle keys \rangle}=\langle values \rangle\}$$

and reset all parameters to their default values with

$$\backslash\resetcharge$$

The `\charge` macro places the $\langle charges \rangle$ out of the bounding box (unless otherwise specified in the $\langle parameters \rangle$) while `\Charge` places them into the bounding box.

The $\langle angle \rangle$ is the location on the boundary of the node where the $\langle charge \rangle$ is placed. This $\langle angle \rangle$ can be expressed in degrees or it can be a boundary anchor in the sense of `tikz`, like "south east." The $\langle shift \rangle$ is a TeX-dimension and represents an additional length between the boundary of the node containing the $\langle atom \rangle$ and the place where the $\langle charge \rangle$ is placed. Unless otherwise specified in the $\langle tikz code \rangle$, the *center* anchor of $\langle charges \rangle$.

In the two following examples, `debug` will be set to $\langle true \rangle$ in order to better perceive the changes induced by the modification of the parameters. In addition, the macro `\Charge` will be used so that the bounding boxes take into account the charges. Here we see the influence of the node shape on the placement of the charges:

Generic example

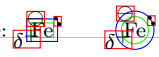
<pre>\setcharge{debug} Default then circle: \Charge{30=\:,120=\$\ominus\$,210=\$\delta^+\$}{Fe}\quad \Charge{[circle]30=\:,120=\$\ominus\$,210=\$\delta^+\$}{Fe}</pre>	Default then circle: 
--	--

To place the loads \ominus and δ^+ further away, we can play on the $\langle shift \rangle$ or better, on the anchor: the $\langle angle \rangle$ where the load is placed is stored in the macro `\chargeangle`, so it is wise to choose the anchor `180+\chargeangle`. It is also possible to specify a circular node to place the charge.

Fine positioning

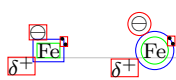
<pre>\setcharge{debug} \Charge{30=\:,120:3pt=\$\ominus\$,210:5pt=\$\delta^+\$}{Fe}\quad \Charge{[circle]30=\:, 120[circle,anchor=180+\chargeangle]=\$\ominus\$, 210[anchor=180+\chargeangle]=\$\delta^+\$}{Fe}</pre>	
--	--

It is important to note that circular nodes have dimensions *sometimes very different* from the "classic" rectangular nodes, especially in terms of horizontal and vertical extent. It is therefore advisable to set $\langle true \rangle$ the boolean key `circle` knowingly.

Circular nodes

<pre>\chemfig{\charge{90=\.}{N}H_3} : rectangle nodes\smallbreak \chemfig{\charge{[circle]90=\.}{N}H_3} : circle node</pre>	$\overset{\cdot}{\text{N}}\text{H}_3$: rectangle nodes _____ NH_3 : circle node _____
---	---

8.3 Lewis formula

When `shortcut` is $\langle true \rangle$, the shortcuts `"\.»`, `"\:»`, `"\|` and `"\"»` are active to draw Lewis formulas `"•»`, `"*»`, `"|»` et `"|»`. You can deactivate them at any time with the `\disables shortcuts` macro and reactivate them with `\enables shortcuts`.

When the boolean `shortcut` is $\langle false \rangle$ or the shortcuts have been disabled with `\disables shortcuts`, shortcuts `"\:`", `"\|`" and `"\"`" are no longer programmed to draw Lewis formulas, so the macros `\chargedot`, `\chargeddot`, `\chargeline` and `\chargerect` must be used instead.

The key `lewisautorot`, which is $\langle true \rangle$ by default, acts on `":`", `"|`" and `"|`" and rotates them.

Autorot

<pre>\Charge{60=\:,150=\"}{A} et \Charge{[lewisautorot=false]60=\:,150=\"}{A}</pre>	$\overset{\cdot}{\text{A}}$ et $\overset{\cdot}{\text{A}}$
---	--

The `lewis` and `Lewis` macros are still functional, but are no longer maintained or documented, and **will be removed in a future version**, so it is advisable to prefer the `\charge` and `\Charge` macros, which give comparable results as shown below, while being much more powerful and configurable:

Comparison with \Lewis

<pre>\Lewis{1:3.5 ,X}\quad\Lewis{0:2.3 ,X}\quad(avec \string\Lewis)\par \Charge{45=\:,135=\.,225=\"}{X}\quad\Charge{0=\:,90=\.,135=\"}{X}% \quad(avec \string\Charge)</pre>	$\overset{\cdot}{\text{X}}$ $\overset{\cdot}{\text{X}}$: (avec <code>\Lewis</code>) _____ $\overset{\cdot}{\text{X}}$ $\overset{\cdot}{\text{X}}$: (avec <code>\Charge</code>) _____
---	---

The customization of Lewis' formulas is done via the macro `\setcharge` or via the optional argument of `\charge` by acting on the keys `.radius`, `.sep`, `.style`, `|style`, `"length`, `"width` and `"style`. It is also possible to modify these keys for each formula with their optional argument which receives a list of `keys = \langle values \rangle`.

Customization

```
\Charge{[.radius=1.5pt,.style={draw=gray}]
  45 =\.[{.style={draw=none,fill=red}}],
  135 =\.[{.style={draw=none,fill=blue}}],
  -45 =\.[{.style={draw=none,fill=green}}],
  -135=\.[A]\quad
\Charge{
  45 =\[{"style={draw=red,fill=gray}}],
  135=\[{"width=3pt,"style={line width=.8pt,draw=blue,fill=cyan}}]{A}
```



8.4 Integration in chemfig

A macro `\charge` can take the place of an atom, just like it did with `\lewis`.

Charge in chemfig

```
\chemfig{H-\chemabove{\lewis{5|7,0}}{\quad\scriptstyle+}(-[2]H)-H}
\quad
\chemfig{H-\charge{45:1.5pt=$\scriptstyle+$,-45=\|,-135=\"}{0}(-[2]H)-H}
```

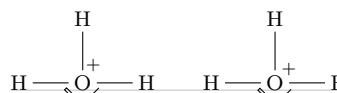

However, `chemfig` has been modified so that the bonds are *joined* when the dimensions of an atom is zero, that is, if its width, height and depth are all 0pt. This was previously only the case if the atom was empty. This new feature makes it easy to place charges in carbon chains.

Charge in chain

```
\chemfig{[:30]-\charge{90=:\}{}}
-[: -30]\charge{-90=\"}{-\charge{90:2pt=$\delta^+}{-[: -30]}}
```



9 Stacking

The macros

$$\backslash\text{chemabove}[\langle dim \rangle]{\langle code \rangle}{\langle stuff \rangle}$$

and

$$\backslash\text{chembelow}[\langle dim \rangle]{\langle code \rangle}{\langle stuff \rangle}$$

place the `⟨stuff⟩` above and below the `⟨code⟩` respectively at a vertical distance `⟨dim⟩`, without changing the bounding box of `⟨code⟩`. The optional argument allows, if written, to specify this dimension at each call. If the optional argument is not used, a default size will be taken: its value is `⟨1.5pt⟩` but it can be modified with the `⟨key⟩` `stack sep = ⟨dim⟩`.

These commands are independent of the macro `\chemfig` and can be used either inside or outside its argument.

They are especially useful in rings, if care is taken to put braces around the letters A, B, C and D in order to prevent `chemfig` from starting a new atom on these letters:

Stacking in rings

```
\chemfig{*5(-\chembelow{A}{B}--\chemabove{C}{D}--)}
```

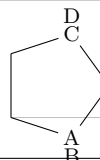

The `\Chemabove` and `\Chembelow` commands work in the same way, except that the bounding box takes into account the `⟨stuff⟩` placed above or below.

What's the difference between `\chemabove` and `\charge` for placing one item above or below another?

\chemabove or \charge

```
\chemfig{*5(----\chemabove{A}{\oplus}--)}
\chemfig{*5(----\charge{90[anchor=-90]=$\oplus$}{A}--)}
```

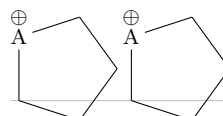

By default, the two macros give very similar results. However, there are differences in their use:

- `\chemabove` and `\chembelow` can only be used in the argument of `chemfig`, which is not the case for `\charge`;
- the `\charge` macro requires `tikz`, whereas `\chemabove` and `\chembelow` use low-level \TeX primitives and are therefore fast and independent of any package.

10 Using `\chemfig` in the `tikzpicture` environment

It is possible to call the `\chemfig` inside a `tikzpicture` environment:

\chemfig inside tikzpicture

```
\begin{tikzpicture}[help lines/.style={thin,draw=black!50}]
  \draw[help lines] (0,0) grid (4,4);
  \draw(0,0) -- (2,1);
  \draw(2,2) circle (0.5);
  \node at (1,3) {\chemfig{A=B-[:30]C}};
  \node[draw,red,anchor=base] at(3,2){\chemfig{X>[2,,,blue]Y}};
\end{tikzpicture}
```

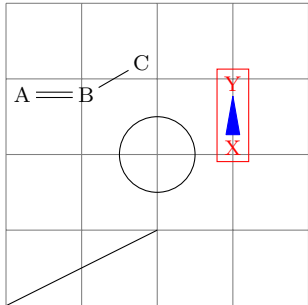

11 Annotated examples

In this chapter, several molecules will be drawn, putting into use the methods previously described. The aim here is to show a logical order for putting together a molecule so that the user unfamiliar with `chemfig` will learn how to construct complex molecules. The construction steps will be shown to help with this learning process.

In addition, several possibilities — some intuitive and others less so — will be shown which give the same graphical results, with the objective being to show that `chemfig` allows some flexibility in encoding molecules. One can see how each is put together and adopt the methods with which one is most comfortable.

11.1 Ethanal

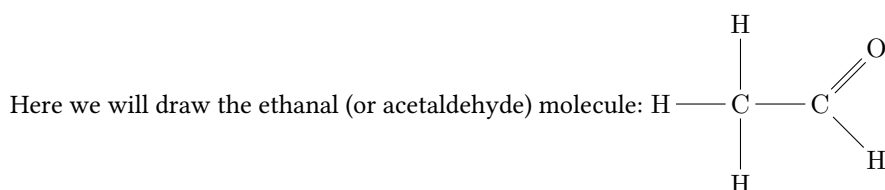

The best method for non-cyclic molecules is to select the longest chain. Here one could take “ $\text{H}-\text{C}-\text{C}=\text{O}$ ” for example. The bond $\text{C}=\text{O}$ is tilted to 45° by using the predefined angle “[1]”. This gives a “backbone” of the molecule to which the branches merely have to be added:

Backbone of ethanal

```
\chemfig{H-C-C=[1]O}
```

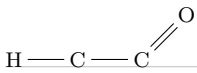

The three hydrogen atoms still have to be placed at the correct orientation with the help of predefined angles. The first is at 90° with the branch “ $(-[2]\text{H})$ ”, the second at 270° with “ $(-[6]\text{H})$ ”, and the one on the right at 315° with “ $(-[7]\text{H})$ ”:

Ethanal

```
\chemfig{H-C(-[2]H)(-[6]H)-C(-[7]H)=[1]O}
```

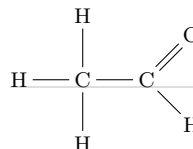

11.2 2-amino-4-oxohexanoic acid

Here is the molecule to be drawn:

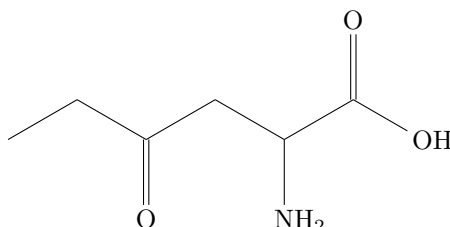

As is often the case for most molecules, there are several methods and for each several different ways of getting the result. Here we will look at four different methods.

11.2.1 Absolute angles

We will first of all draw the central chain with absolute angles. We set the default angle to $+30^\circ$ with the optional argument, and so only the descending bonds need to have their absolute angle set to -30° :

Backbone (absolute angles)

```
\chemfig{[:30]--[:-30]--[:-30]--[:-30]OH}
```

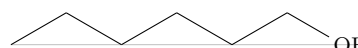

The branches “(=[6]O)”, “(-[6]NH₂)” and “(=[2]O)” still have to be added to the correct vertices:

Molecule (absolute angles)

```
\chemfig{[:30]--[:-30](=[6]O)--[:-30](-[6]NH_2)-(=[2]O)-[:-30]OH}
```

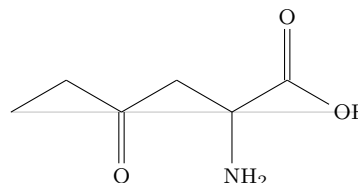

11.2.2 Relative angles

A more general approach uses only relative angles, in this way:

Structure (relative angles)

```
\chemfig{[:30]--[::-60]--[::-60]--[::-60]OH}
```

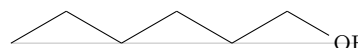

then

Molecule (relative angles)

```
\chemfig{[:30]--[::-60](=[::-60]O)--[:-60](-[:-60]NH_2)  
-(=[::60]O)-[:-60]OH}
```

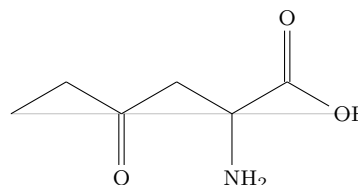

11.2.3 Ring

Since the angles between the bonds are 120° , it is possible to use a 6-ring, although this method is less natural. Here we take advantage of the fact that a ring can be left unfinished. The ring must be rotated 120° so that the first vertex is to the south-east of the ring:

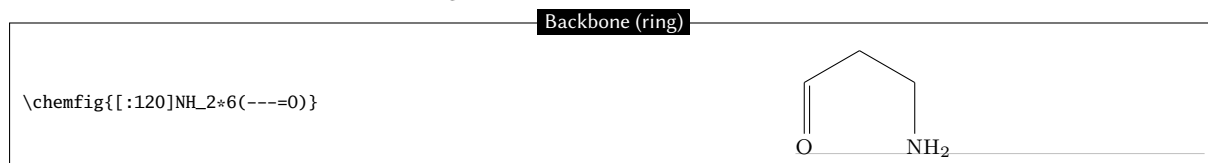

Now the branches must be added to the right vertices:

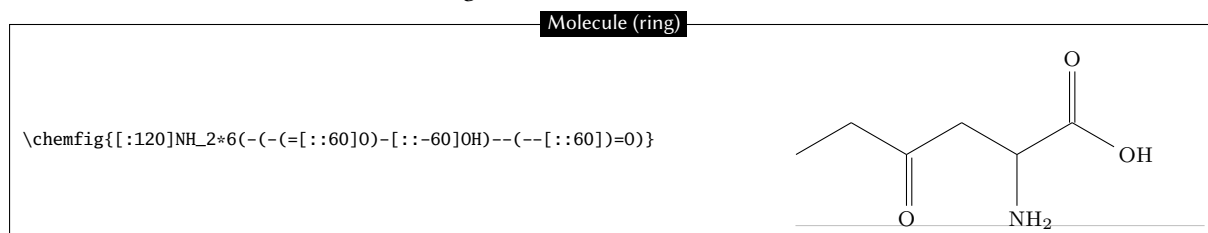

11.2.4 Nested rings

Delving deeper into the ring method, we can also consider nesting incomplete 6-rings. We could start with this backbone:

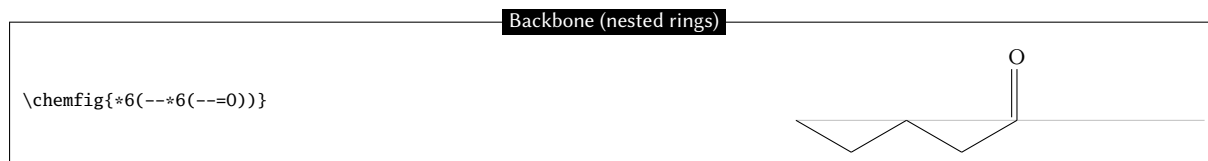

And then add the bonds which leave the vertices of these rings. There are no angles to worry about because the bonds leaving the rings are the bisectors of the sides of the ring, exactly what we want here:

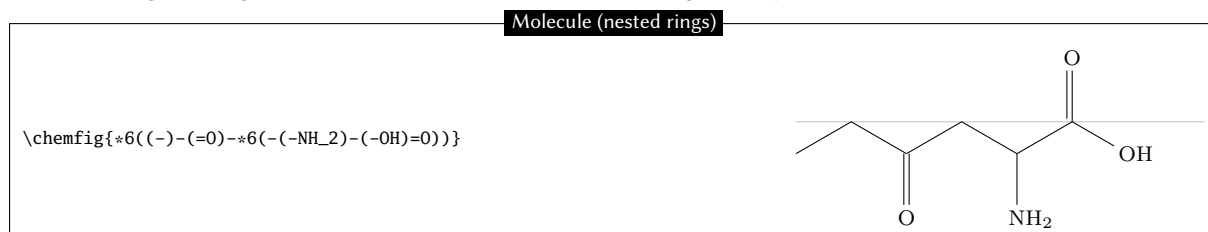

A close look shows that the second line segment of the double bond to the oxygen atom is *inside* the incomplete 6-ring⁹. Despite its brevity, this code does not give a perfect drawing. This can of course be corrected by adding a little to the code:

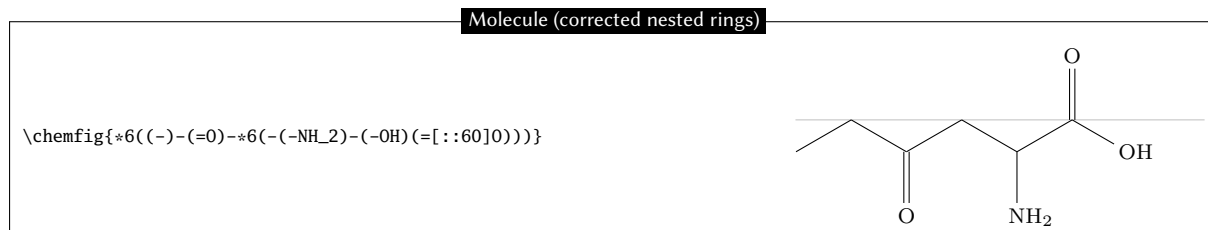

11.3 Glucose

The goal here is to represent the glucose molecule according to several different conventions.

⁹This was also true for the preceding method with one ring.

11.3.1 Skeleton diagram

The code here looks like that of 2-amino-4-oxohexanoic acid. This gives almost the same structure with absolute angles, except here the default angle is -30° :

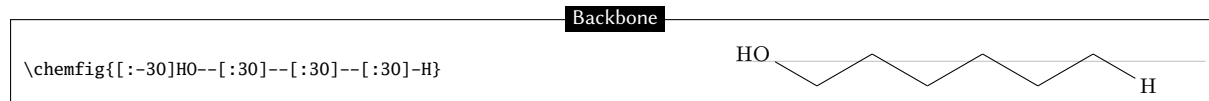

Adding the branches is no problem. We use predefined absolute angles:

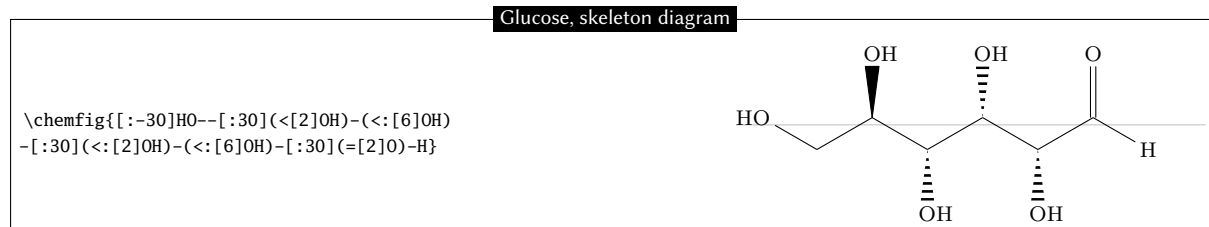

11.3.2 Fisher projection

The goal is to get the molecule below:

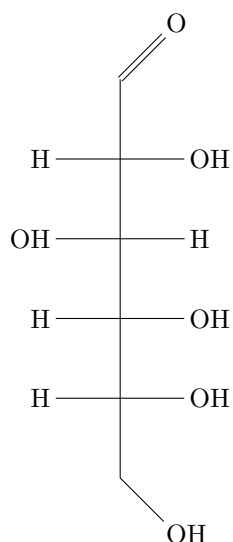

The idea is to begin to draw the longest chain vertically by giving a default angle of “[2]”. Here is the skeleton, where we have added lower case letters at the end of each vertical bond:

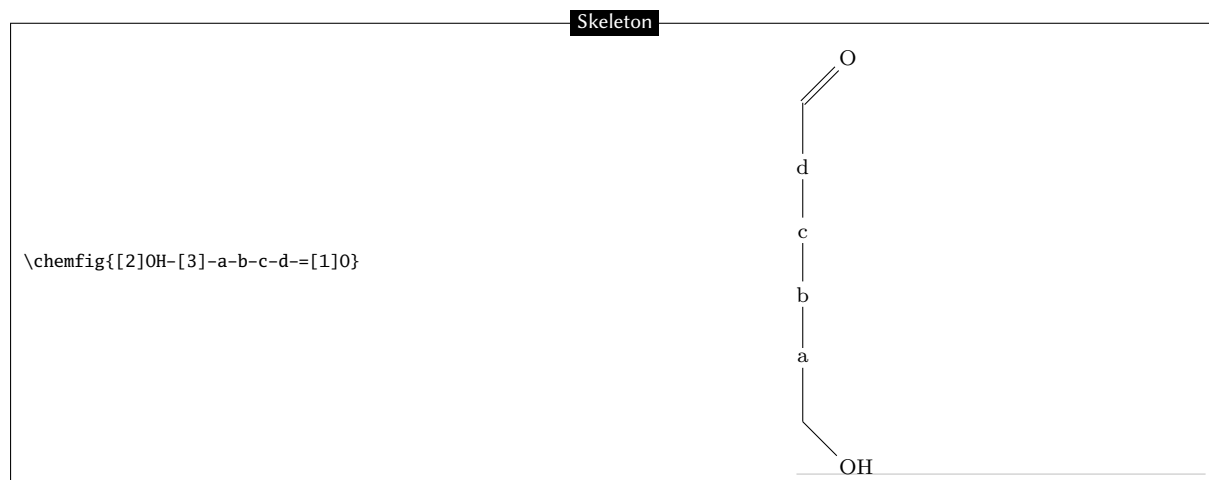

Next we define two aliases for the horizontal bonds and the atoms at their ends. Lets choose “x” which we will put in place of the lower case a, c and d, and “y” which will replace the letter c. Since these alias are just one character, we do not need braces and can write “!x” instead of “!{x}”:

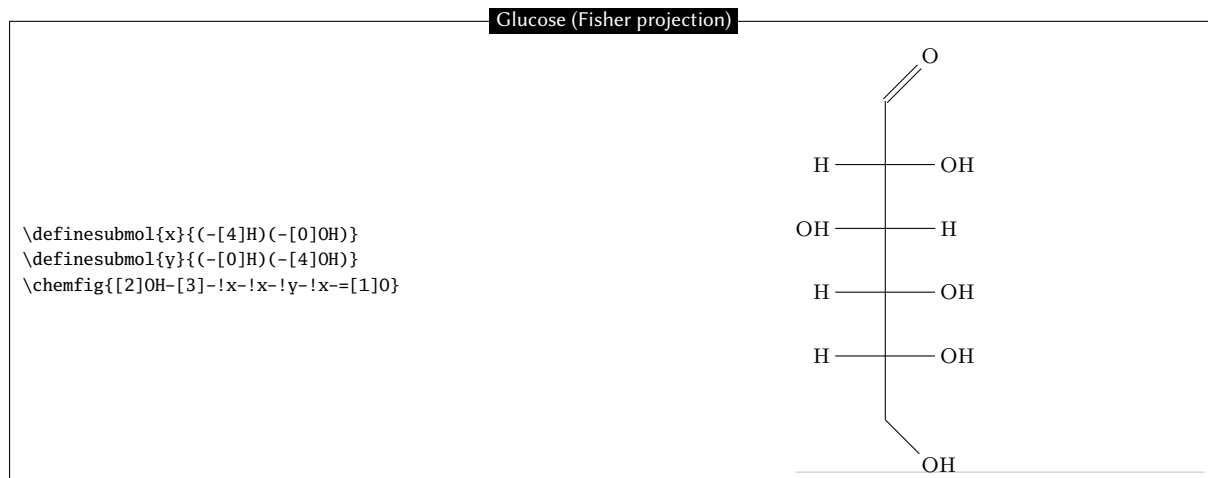

11.3.3 “Chair” representation

We will depict the α -D-glucose molecule:

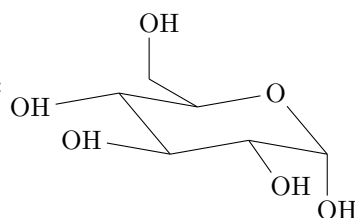

To do this, we will first of all draw five sides of the chair and link the first vertex to the last with a hook “?”. We will use the following absolute angles, running counterclockwise: -50° , 10° , -10° , 130° , 190° .

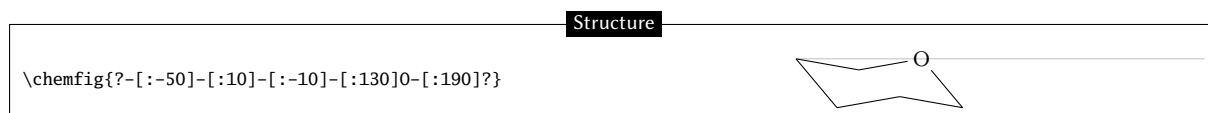

Now we simply add the branches inside parentheses. The angles are chosen to give the best impression of perspective, and some bonds are shortened by a factor of 0.7:

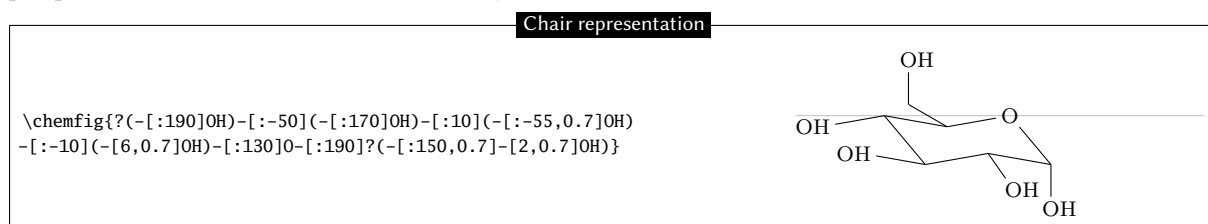

11.3.4 Haworth projection

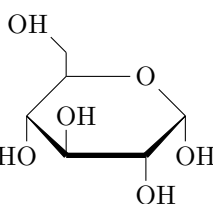

The goal is to depict this D-glucopyranose molecule: HO

First of all we will choose the longest chain, which starts at the “HO” group on the left and continues through five sides of the ring. The ring will be closed with a hook. For the vertical bond which leaves from the first “HO”

group, we need to specify that it will leave from the second atom using the optional argument. Furthermore, it will be shortened with a coefficient of 0.5. Its optional argument will thus be “[2,0.5,2]”.

Next, to give the impression of perspective to the ring, the diagonal bonds will be shortened by a coefficient of 0.7. For the bold diagonal lines we will use Cram bonds, having redefined the base of the triangles to be 2pt. The bold horizontal bond needs to be drawn with a thickness of 2pt, and so its optional argument will be “[0,,,line width=2pt]”. Here is the skeleton of the molecule:

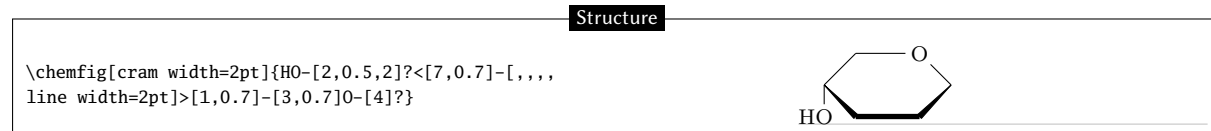

All that needs to be done now is to add the branches at the correct places, giving the right absolute angles and sometimes reducing the length to better give the illusion of perspective:

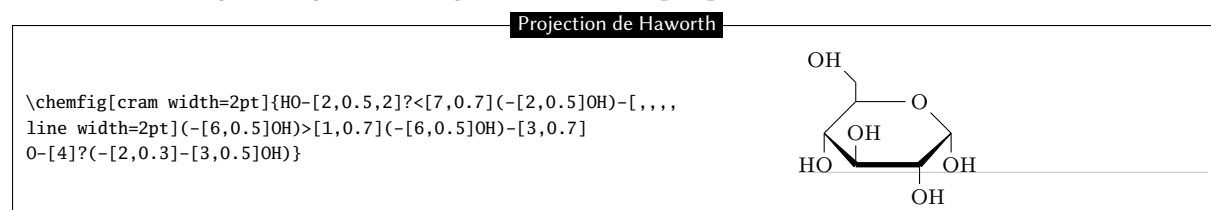

11.4 Adrenaline

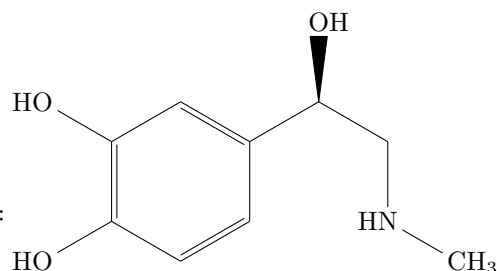

We want to draw the adrenaline molecule:

We are going to use two different methods.

11.4.1 Using one ring

First of all, we start with a 6-ring and we draw the start of the branches which leave it:

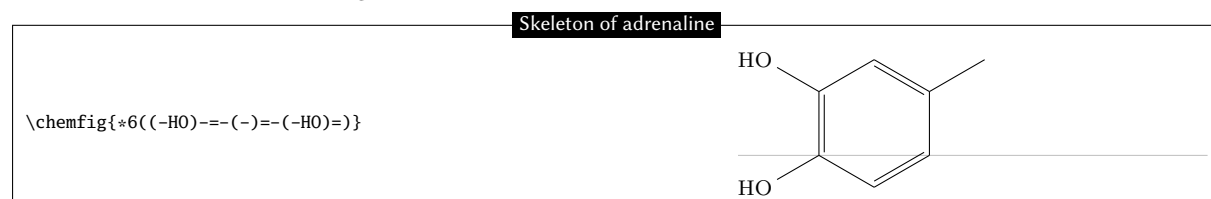

The branch on the right still needs to be completed using, for example, relative angles:

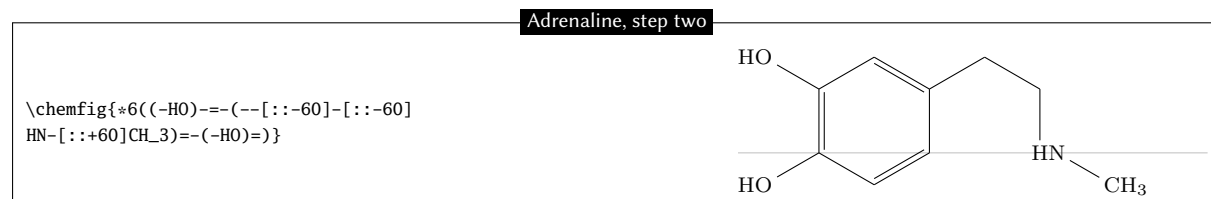

Then we need to add a Cram-bonded OH and indicate that the bond which arrives at “HN” does so on the second atom, i.e., “N”. We use the fourth optional argument of the bond:

Adrenaline

```
\chemfig{*6((-HO)--(-(<[:60]OH)-[:60]-[:60,,,2]
HN-[:60]CH_3)-(-HO)=)}
```

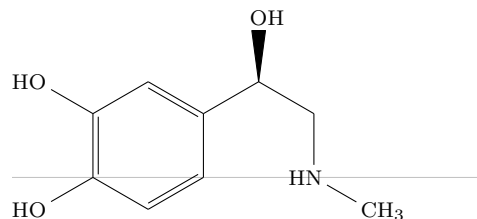

11.4.2 Using two rings

This method is less natural, but the goal is to show here how to make a bond invisible.

We could improve this code by considering that the drawing of the adrenaline molecule is made of two 6-rings adjacent to each other:

Adrenaline, two-ring skeleton

```
\chemfig{*6((-HO)-=*6(--HN---)--(-HO)=)}
```

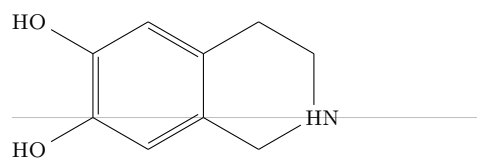

Now the first two bonds of the ring on the right need to be made invisible. To do this we use the argument that is passed to `tikz`, specifying “`draw=none`”. These bonds will thus have this code: “`-[,,,,draw=none]`”. To keep the code readable, we define an alias named “`&`” for these bonds:

Adrenaline, step two

```
\definesubmol{&}{-[,,,,draw=none]}
\chemfig{*6((-HO)-=*6(!&HN---)--(-HO)=)}
```

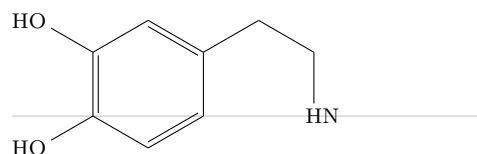

The rest becomes easy; just add the branches to the right vertices:

Adrenaline, step three

```
\definesubmol{&}{-[,,,,draw=none]}
\chemfig{*6((-HO)-=*6(!&HN(-CH_3)-(<OH)-)--(-HO)=)}
```

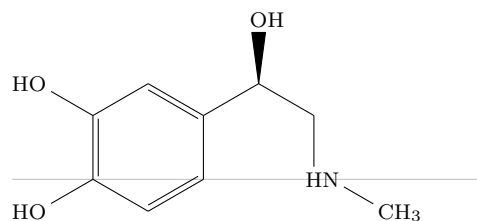

To finish, we specify that the bonds that *arrive at and leave from* “HN” must do so at the second atom. We therefore define another alias for the invisible bond which arrives at “HN”:

Adrenaline

```
\definesubmol{&}{-[,,,,draw=none]}
\definesubmol{&&}{-[,,,,2,draw=none]}
\chemfig{*6((-HO)-=*6(!&{&&HN(-CH_3)-[, ,2]-(<OH)-)--(-HO)=)}
```

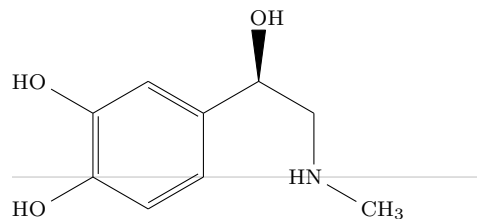

11.5 Guanine

We will draw the guanine molecule:

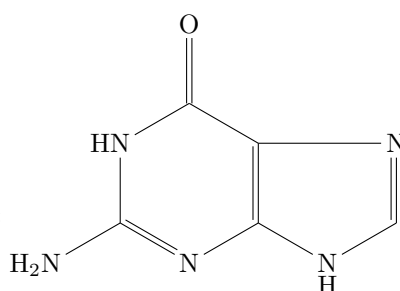

First of all, let's begin by drawing the nested rings, putting just the nitrogen atoms at the vertices:

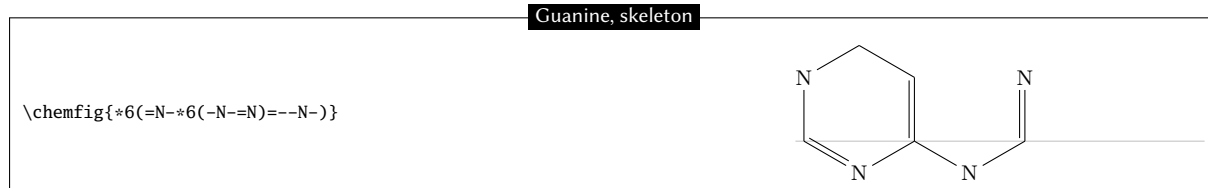

Then we can draw the horizontal bond in the right ring with a hook. We will also place a hydrogen atom under the nitrogen atom of the 5-ring with the command `\chembelow{N}{H}`. We also need to write “HN” instead of “N” at the vertex at the upper left of the molecule:

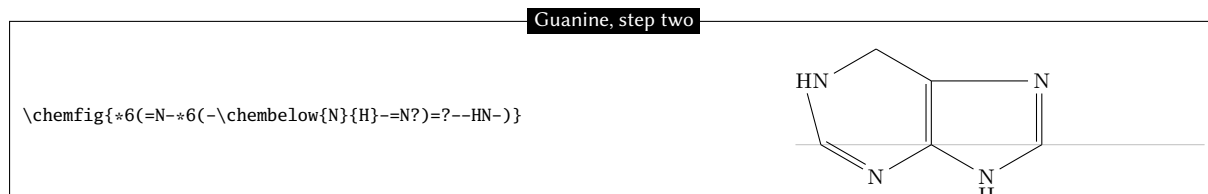

We note that one bond leaves from the wrong atom¹⁰! The automatic calculation mechanism must be corrected so that the bond leaves from the second atom “N” instead of the first. To do this we give an optional argument for the last bond of the first 6-ring “[, , 2]”:

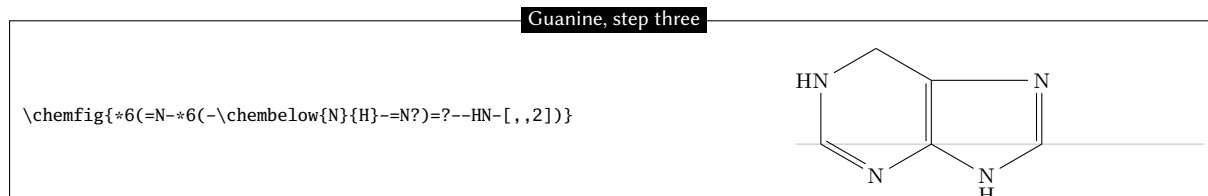

Simply add the branches to the right vertices. Note especially the branch leaving the first vertex of the first 6-ring “(-N_2N)”:

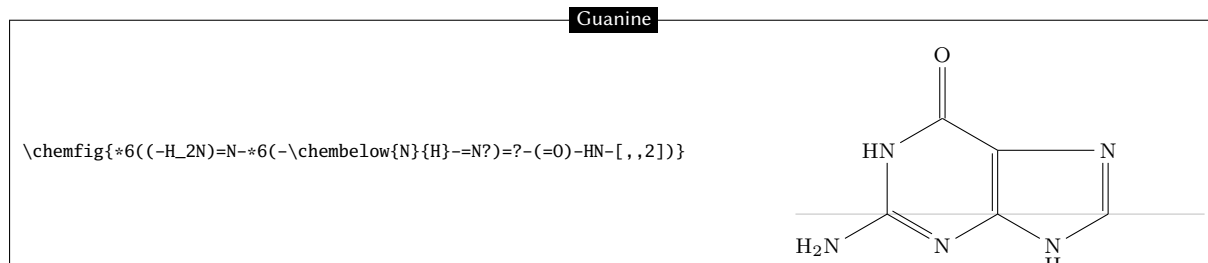

We could also draw the same molecule with a regular 5-ring, as is sometimes done:

¹⁰This seems illogical because the angle of the bond from the HN group toward the first vertex lies between -90° and 90° ; chemfig should therefore leave from the second atom. To explain this contradiction, one must know that in rings, the last bond always links the last vertex to the first, ignoring the *calculated theoretical* angle of this bond (which here is -90°). chemfig uses this theoretical angle to determine the departure and arrival atoms, but does not use it to draw the bond because the two ends are already defined. The departure atom for the last bond is thus the first atom.

```
\chemfig{*6((-H_2N)=N-*5(-\chembelow{N}{H})-N-)-=(=O)-HN-[ , , 2]}
```

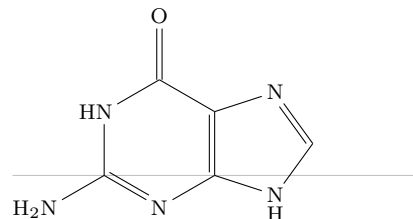

12 How to ...

12.1 Write a colored atom

Since the package `xcolor` is loaded by `tikz`, itself loaded by `chemfig`, we can write color commands in the code of a molecule, mainly `\color` and `\textcolor`. The atoms are displayed in `tikz` nodes which behaves like boxes of \TeX and it is as if these atoms were put in a group. Therefore, the color change remains local to the atom.

Colors

```
\chemfig{C\color{blue}H_3-C(=[1]O)-[7]O\color{red}H}
```

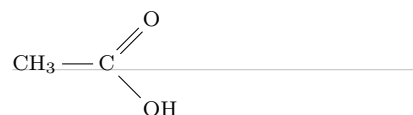

This code does not work, because of the rule used to separate atoms: here, the first atom starts at “C” and spreads to the next uppercase letter. Therefore, this atom is “C\color{blue}” and the color change occurs at the end of atom and has no effect. We need to force `chemfig` to cut the first atom just after “C” with the character “|” and then include `\color{blue}H_3` between braces so that `chemfig` does not stop the atom 2 before the uppercase “H” which would leave the color change alone and therefore ineffective in an atom:

Colors

```
\chemfig{C|{\color{blue}H_3}-C(=[1]O)-[7]O|{\color{red}H}}
```

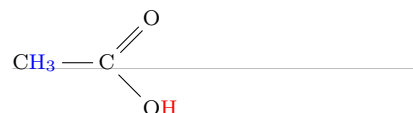

The same effect can be obtained with `\textcolor`:

Colors

```
\chemfig{C|\textcolor{blue}{H_3}-C(=[1]O)-[7]O|\textcolor{red}{H}}
```

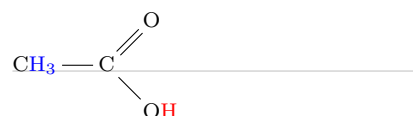

The main disadvantage is that we have to do the same for every atom that need to be colored, even if they are contiguous.

12.2 Add a superscript without modifying a bond

Adding a charge to an atom with a mathematical exponent implies that the box (and therefore the `tikz` node) containing the atom has its dimensions modified. It has no importance when the atom is trailing but the alignment may be compromised if a bond is attached to the atom. The first reaction is to put the charge in a box with no width and therefore use the command `\rlap`¹¹, which often gives good results. We see here that with `\rlap`, the horizontal alignment of atoms is preserved:

Charge and bond

```
\chemfig{A^{+-}[2]B}
\qqquad
\chemfig{A\rlap{^{+}}-[2]B}
```



¹¹If you have to put the charge at the left of the atom, you must use the command `\llap`.

The macro `\charge` allows this task to be performed simply and accurately.

Placing charges

```
\chemfig{\charge{[extra sep=0pt]45[anchor=180+\chargeangle]=%
$\scriptstyle\oplus$}{A}-[2]B}
\quad
\chemfig{*5(---\charge{90:2pt=$\scriptstyle\oplus$}{-}%
\charge{135:2pt=$\scriptstyle-$}{-})}
```

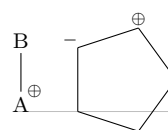

12.3 Draw a curve bond

We have already seen that with the `tikz` library “`decorations.pathmorphing`”, we can draw a wavy bond:

Wavy bond

```
\chemfig{A-[ , 3 , , decorate, decoration=snake]B}
\chemfig{A-[ , 3 , , decorate, decoration={snake, amplitude=1.5mm,
segment length=2.5mm}]B}
```

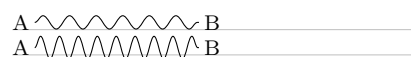

For more flexibility, you can also define nodes using the character “@” and reuse these nodes after the molecule has been drawn to connect them with a curved line using `\chemmove`:

Curved bonds

```
\chemfig{@{a}A-[ , , , draw=none]@{b}B}
\chemmove{\draw[-](a)..controls +(45:7mm) and +(225:7mm)..(b);}
\bigskip
\chemfig{*6(@{a}---@{b}---)}
\chemmove{\draw[-](a)..controls +(60:3em) and +(240:3em)..(b);}
\quad
\chemfig{*6(@{a}---@{b}---)}
\chemmove{\draw[-](a)..controls +(60:3em) and +(30:1em)..
++(20:2em) ..controls +(210:3em) and +(-120:4em) ..(b);}
```

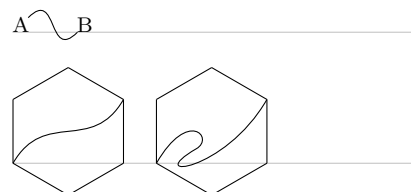

12.4 Draw a polymer element

The macro `\polymerdelim`, until now undocumented and in the test phase, becomes officially released in `chemfig` with version 1.33. Its syntax is as follows:

$$\backslash\text{polymerdelim}[\langle\text{keys}\rangle=(\langle\text{values}\rangle)]\{\langle\text{node1}\rangle\}\{\langle\text{node2}\rangle\}$$

The effect, after possibly *two* compilations, is to place vertical delimiters at the specified nodes. The parameters are specified via the $\langle\text{keys}\rangle$ and $\langle\text{values}\rangle$, which are listed below, default values and actions.

	$\langle\text{keys}\rangle$	default $\langle\text{values}\rangle$	Action
	<code>delimiters</code>	<code>()</code>	Defines the delimiters. If these delimiters are brackets, write <code>delimiters={[]}</code> .
	<code>height</code>	<code>10pt</code>	Defines the height (above the node) of the delimiters.
	<code>depth</code>	$\langle\text{vide}\rangle$	Defines the depth (below the node) of the delimiters. If the $\langle\text{value}\rangle$ is empty, then the depth is equal to the height.
	<code>h align</code>	<code>true</code>	Boolean which, when $\langle\text{false}\rangle$, places the 2nd delimiter on the 2nd node, at the risk that the delimiters are not on the same horizontal line.
	<code>auto rotate</code>	<code>false</code>	Boolean which, when $\langle\text{true}\rangle$ and <code>h align = $\langle\text{false}\rangle$</code> , automatically turns the delimiters to be perpendicular to the line that connects the two nodes.
	<code>rotate</code>	<code>0</code>	When <code>h align = $\langle\text{false}\rangle$</code> and <code>auto rotate = $\langle\text{false}\rangle$</code> , sets the rotation angle of the two delimiters.
	<code>open xshift</code>	<code>0pt</code>	Defines the horizontal offset of the opening delimiter.
	<code>close xshift</code>	$\langle\text{vide}\rangle$	Defines the horizontal offset of the closing delimiter. If the $\langle\text{value}\rangle$ is empty, then this offset becomes opposite to the offset of the opening delimiter.
	<code>indice</code>	<code>n</code>	Defines the indices that will be placed at the right bottom of the closing delimiter.

Polyethylen:

```
\chemfig{\vphantom{CH_2}-[@{op,.75}]CH_2-CH_2-[@{cl,0.25}]}
\polymerdelim[height = 5pt, indice = \!\!n]{op}{cl}
\bigskip
```

Polyvinyl chloride:

```
\chemfig{\vphantom{CH_2}-[@{op,1}]CH_2-CH(-[6]Cl)-[@{cl,0}]}
\polymerdelim[height = 5pt, depth = 25pt, open xshift = -10pt, indice = \!\!n]{op}{cl}
\bigskip
```

Nylon 6:

```
\chemfig{\phantom{N}-[@{op,.75}]{N}(-[2]H)-C(=[2]O)-{CH_2}_5-[@{cl,0.25}]}
\polymerdelim[height = 30pt, depth = 5pt, indice = {}]{op}{cl}
\bigskip
```

Polycaprolactame

```
\chemfig[atom sep = 2em]{[: -30]-[@{left,.75}]N(-[6]H)-[:30](=[2]O)--[:30]-[:30]-[@{right,0.25}:30]}
\polymerdelim[height = 5pt, indice = \!\!n]{left}{right}
\bigskip
```

Polyphenyl sulfide:

```
\chemfig{\vphantom{S}-[@{op,.75}]S-(**6(---(-[cl,0.25])---))}
\polymerdelim[delimiters = (), height = 15pt, indice = {}]{op}{cl}
\bigskip
```

```
\chemfig{-CH_2-CH([6]-CO-NH-CH_2-NH-CO-CH([4]-CH_2-)([0]-[@{downleft,0.8},2]CH_2
-CH([2]-CO-NH_2)-[@{downright,0.3},2]CH_2-[1.5]C?H-)-[@{upleft,0.8},2]CH_2
-CH([6]-CO-NH_2)-[@{upright,0.3},2]CH_2-[1.5]CH([6]-CO-NH-CH_2-NH-C?O)-}
\polymerdelim[delimiters = {[}], height = 5pt, depth = 40pt, indice = n]{upleft}{upright}
\polymerdelim[delimiters = {[}], height = 40pt, depth = 5pt, indice = n]{downleft}{downright}

\chemfig{-[@{op,.5}:-30]O-[:60](=[:60]O)-[:-60]*6(---(-[cl,0.25])---)}
\polymerdelim[height=6ex, indice=n, h align=false]{op}{cl}
```

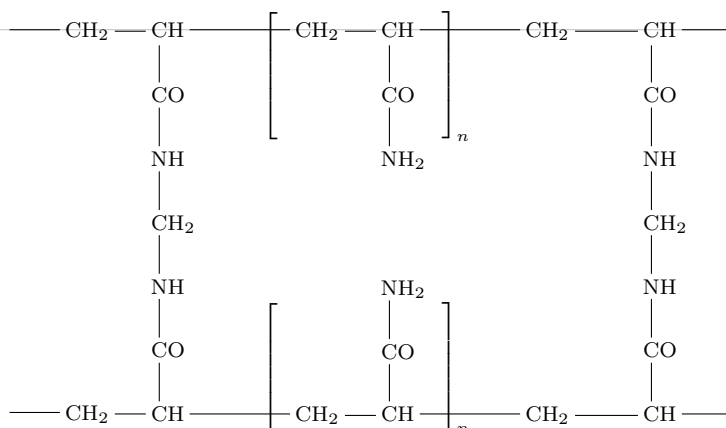
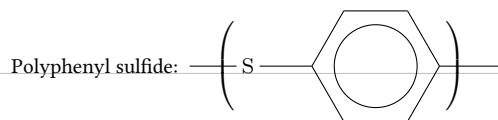
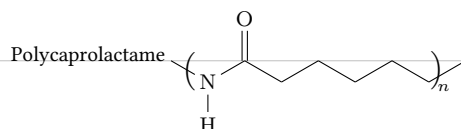
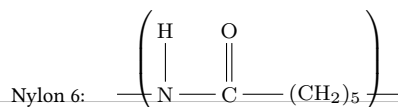
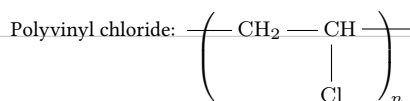
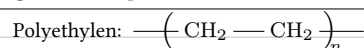

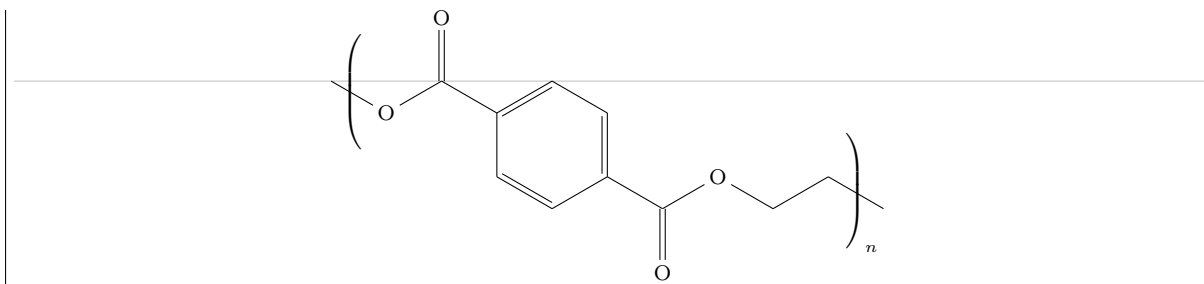

12.5 Draw the symmetrical of a molecule

The two commands `\hflipnext` and `\vflipnext` allow to draw the symmetrical of the next molecule about a horizontal or vertical axis. If we want to draw more symmetrical molecules, we need to write these commands before each molecule involved.

Symmetry

```
\chemfig{H_3C-C(=[:30]O)-[:-30]OH}% original
\vflipnext
\chemfig{H_3C-C(=[:30]O)-[:-30]OH}\medskip
\chemfig{H_3C-C(=[:30]O)-[:-30]OH}% original
\hflipnext
\chemfig{H_3C-C(=[:30]O)-[:-30]OH}
```

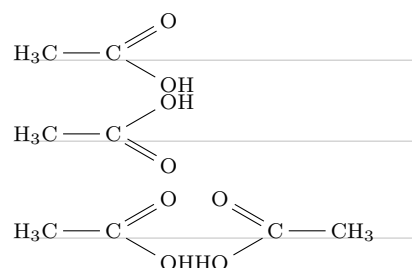

12.6 Add text above bonds and arc to angles

Once we have understood that the character “@” can put a “global” `tikz` node, that is to say a node accessible after the molecule has been drawn, everything that `tikz` can do with nodes (that is to say a lot of things) becomes possible.

To write something above or below a bond, we can put two “global” nodes on the atoms at the ends of this bond and write midway between them a text, raised or lowered so that it falls to just above or below the bond. This is done by the macro `\bondname` in the code below.

To draw an arc between two bonds, three atoms are involved on which we have to put three “global” nodes. The macro `\arcbetweennodes` calculates the angle between two lines drawn from a node. Then `\arclabel` draws an arc between two bonds and writes a text next to the arc: the optional argument of this macro is the `tikz` code used to custom the arc. The second argument is the radius of the arc and the following three arguments are the names of global nodes between which the arc must be drawn, the middle name needs to be the vertex of the angle. The last argument is the text to write.

Arcs and text on bonds

```
\newcommand\angstrom{\mbox{\normalfont\AA}}
\newcommand\namebond[4][5pt]{\chemmove{\path(#2)--(#3)node[midway,sloped,yshift=#1]{#4};}}

\newcommand\arcbetweennodes[3]{%
  \pgfmathanglebetweenpoints{\pgfpointanchor{#1}{center}}{\pgfpointanchor{#2}{center}}%
  \let#3\pgfmathresult}

\newcommand\arclabel[6][stealth-stealth,shorten <=1pt,shorten >=1pt]{%
  \chemmove{%
    \arcbetweennodes{#4}{#3}\anglestart \arcbetweennodes{#4}{#5}\angleend
    \draw[#1](\shift=(\anglestart:#2)#4)arc(\anglestart:\angleend:#2);
    \pgfmathparse{(\anglestart+\angleend)/2}\let\anglestart\pgfmathresult
    \node[\shift=(\anglestart:#2+1pt)#4,anchor=\anglestart+180,rotate=\anglestart+90,inner sep=0pt,
      outer sep=0pt]at(#4){#6};}}

\chemfig{@{a}A=[:30,1.5]@{b}B-[7,2]@{c}C-@{d}D}
\namebond{a}{b}{\scriptsize My text}
\namebond[-3.5pt]{b}{c}{\small\color{red}$\pi$}
```

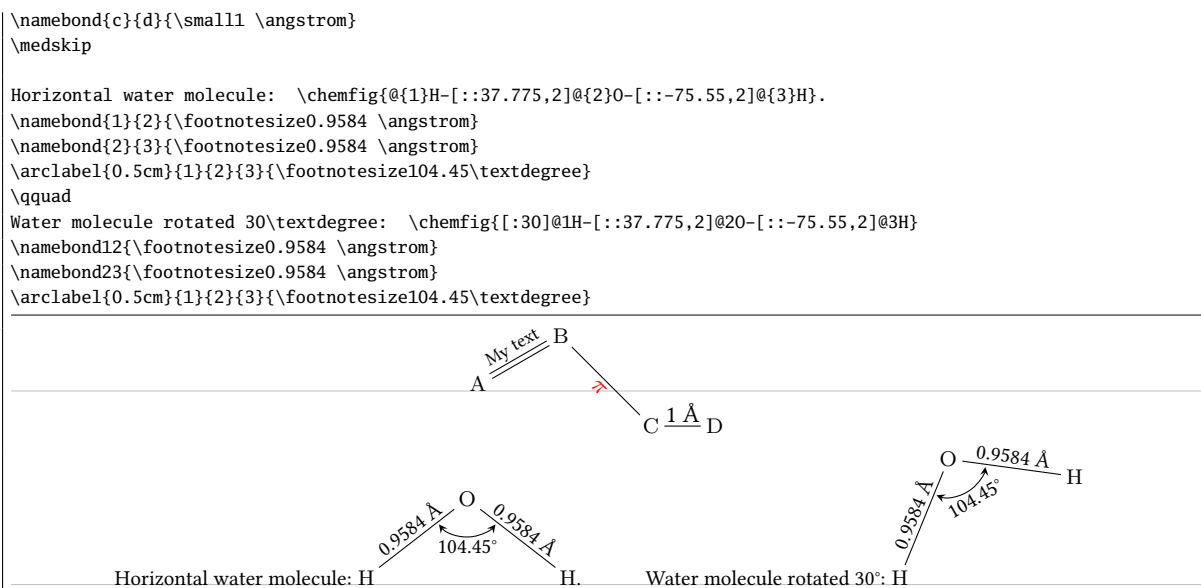

12.7 Dessiner des liaisons multiples

Again, the “decorations.markings” library allows to draw multiple bonds:

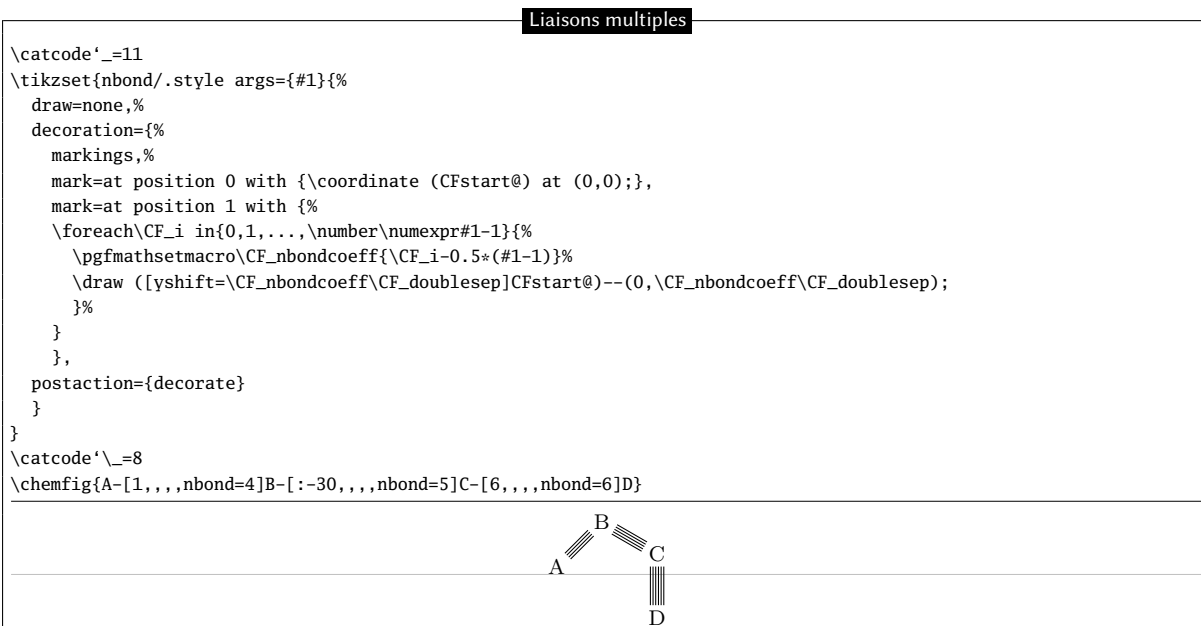

Reaction schemes

Following several requests from users, it had become evident that `chemfig` had a weakness regarding the drawing of reaction schemes. The gap is now filled. Therefore, `chemfig` has now reached version 1.0 since I consider that the main features sought are now available.

I thank Clemens NIEDERBERGER for his help and the tests he carried out on the new features presented in this part.

1 Overview

A reaction scheme must be contained between the commands “\schemestart” and “\schemestop”. As shown in this example, debug information is either hidden or displayed with the *key* `scheme debug` and the value *key* (`true`) or (`false`):

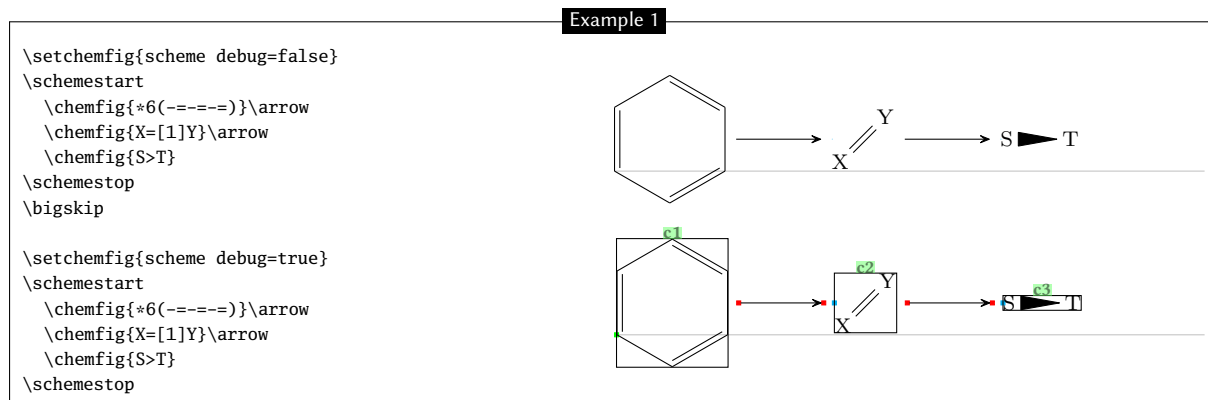

Some comments:

- the `\arrow` commands draw the arrows;
- everything lying between two `\arrow` commands is considered a compound. It was decided that all possible settings, whether for arrows or compounds, are controlled by the arguments of the `\arrow` command, whose syntax may become quite complex;
- arrows are plotted horizontally, this can obviously be modified;
- arrows are plotted on the imaginary line connecting the center of the compounds' bounding boxes (the red and blue squares are the anchoring points of arrows). This behavior can also be modified;
- debug information is displayed with the `scheme debug key`. It consists of:
 - the green label above the bounding boxes is the default name assigned to compounds by `chemfig`. It follows the series "c1", "c2", etc. Numbering is reset to 1 for every reaction scheme.
 - display of the compounds bounding boxes;
 - the arrows start and end points represented by red points and anchors by blue points;
- the distance from edge to edge between two compounds is defined with the *key* `compound sep = dim`. By default this *dim* is 5em;
- finally, the distance between the edges of the compounds and the beginning and end of the arrows is defined with the *key* `arrow offset = dim`. By default, this *dim* is 4pt.

2 Arrow types

When the `\arrow` command is followed by an optional argument in braces (which is not mandatory), the argument defines the type of arrow:

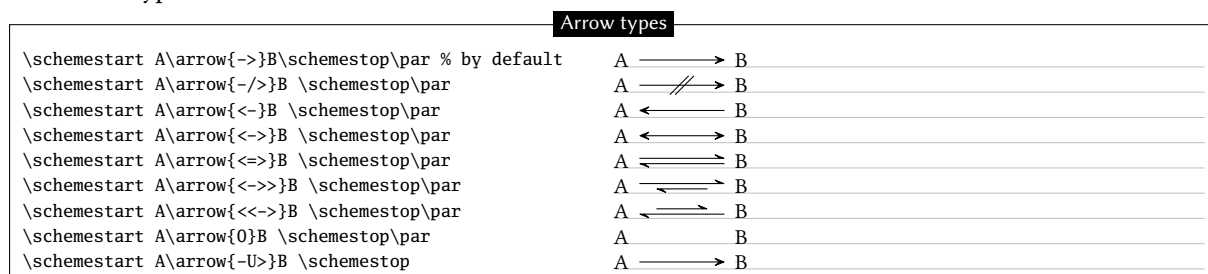

The arrow “-U>” is not fully drawn, an arc can be added tangent to the arrow center using optional arguments on

the command, see page 56. Here is a “-U>” arrow with the arc on top of it: A B

For the sake of clarity, capital letters will be used throughout the documentation instead of chemical formulas made with the `\chemfig` command except for specific examples. Reaction schemes obviously work identically with letters and drawn molecules. Several examples are shown in the Gallery with proper reaction schemes.

3 Arrows features

Each arrow is characterized by:

- an angle expressed in degrees;
- a coefficient that specifies the arrow length through the multiplication of the compounds spacing value defined by `compound sep`;
- a style with `tikz` instructions to customize the color, the thickness or other graphical attribute of the arrow.

These features are defined with the `<keys>`

- `arrow angle = <angle>`, which default value is 0;
- `arrow coeff = <decimal>`, which default value is 1;
- `arrow style = <code tikz>`, empty by default.

Definition of default values

<pre>\schemestart A\arrow B\arrow C\schemestop</pre>	
<pre>\setchemfig{arrow angle=15,arrow coeff=1.5, arrow style={red, thick}} \schemestart A\arrow B\arrow C\schemestop</pre>	
<pre>\setchemfig{arrow coeff=2.5,arrow style=dashed} \schemestart A\arrow B\arrow C\schemestop</pre>	
<pre>\setchemfig{arrow angle={},arrow coeff={},arrow style={}} \schemestart A\arrow B\arrow C\schemestop</pre>	

In order to locally modify one or all of these default values, the `\schemestart` command accepts an optional argument in the form `[angle,coeff,style]` which changes the default arrow features within the sole reaction scheme:

Optional argument

<pre>\setchemfig{arrow angle=5,arrow coeff=2.5,arrow style=blue} \schemestart A\arrow B\arrow C\schemestop</pre>	
<pre>\schemestart[0] A\arrow B\arrow C\schemestop</pre>	
<pre>\schemestart[0,1] A\arrow B\arrow C\schemestop</pre>	
<pre>\schemestart[0,1,thick] A\arrow B\arrow C\schemestop</pre>	
<pre>\schemestart[0,1,black] A\arrow B\arrow C\schemestop</pre>	

Regarding style, the rule is: the style specified in the argument in brackets applies *after* the default style, without overwriting it! This is why only the “black” color attribute is able to overwrite the “blue” default style.

Finally, the `\arrow` command accepts an optional argument in brackets in the form `[angle,coeff,style]` to change the feature of that given arrow. As above, style applies *after* the default style and *after* the style possibly-specified in the optional argument of the `\schemestart` command, again without overwriting them.

Arrows features

<pre>\schemestart A\arrow[45]B\arrow[-20,2]C \schemestop \bigskip</pre>	
<pre>\schemestart A\arrow[90,,thick]B\arrow[,2]C \arrow[-45,,dashed,red]D \schemestop</pre>	

4 Compounds names

Automatic naming of compounds (“c1”, “c2”, etc.) can be overridden. For this, the `\arrow` command must be immediately followed by an argument in parentheses. The argument is of the form: (n1--n2). The compounds located at the beginning and at the end of the arrow are named “n1” and “n2”, respectively. Any alphanumeric string can be used. The numbering of the names “c<n>” continues internally, so if a compound has a different name than the default one, it does not affect the default name of the subsequent compounds.

Names are optional, and the argument can be either (n1--) and (--n2).

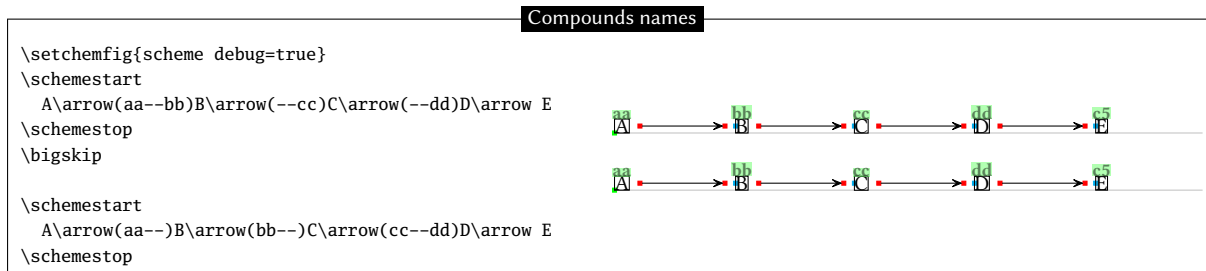

Note that both methods are equivalent. Therefore, compounds can either be named by arrows preceding or following them. However, when a compound is surrounded by two arrows specifying its name, the first name is ignored and a warning message is generated:

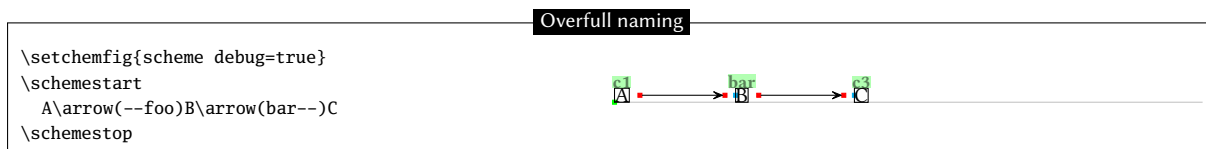

Here compound “B” is called “foo” by the arrow pointing at it, and “bar” by the arrow leaving from it. Thus `chemfig` generates a warning mentioning that the name “foo” will be ignored:

Package chemfig Warning: two names for the same node, first name "foo" ignored

5 Anchoring

As noted above, arrows lie on the line connecting the center of the compounds’ bounding boxes. Default anchors are called “center” in the sense of `tikz`. Non-default anchoring points can be user-specified as well with an argument between brackets:

(n1.a1--n2.a2)

where the anchor “a1” or “a2” can be: north west, north, north east, west, center, east, mid west, mid, mid east, base west, base, base east, south west, south, south east, text, or any angle. Here is an example from the `tikz` manual where the anchors are located on the bounding box:

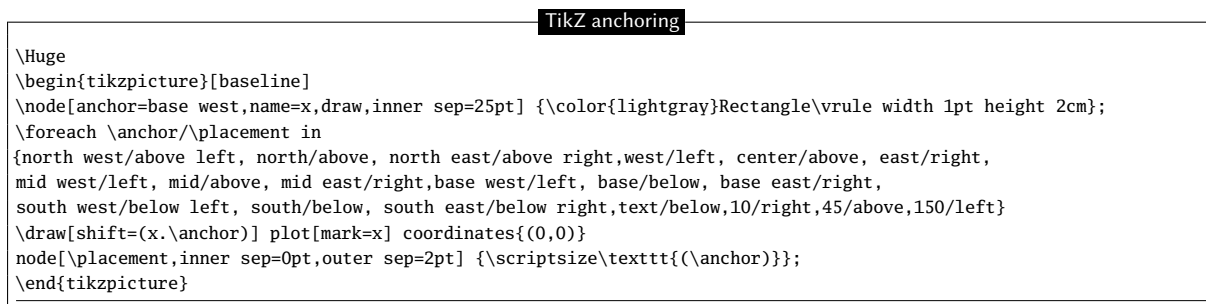

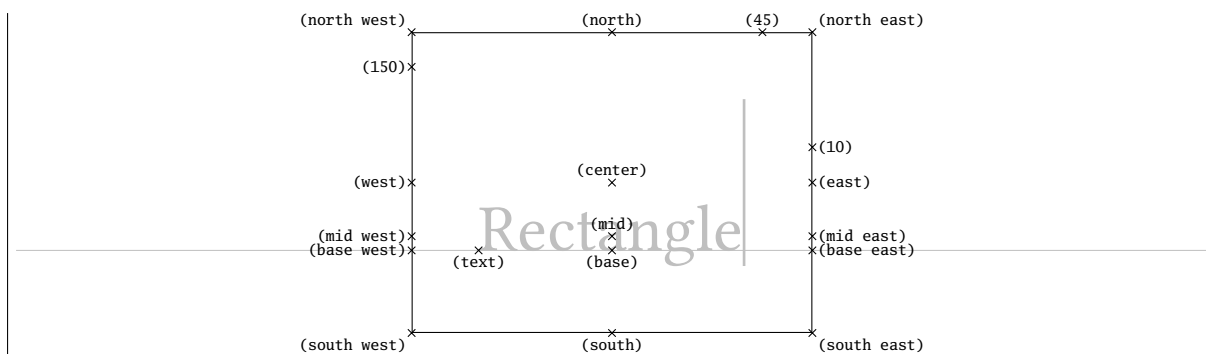

Like for names, arrival and departure anchoring points are independent and optional.

In this example, the default alignment is not good because the two “A” are not aligned vertically. Debug information show that the default “center” anchors are not suitable:

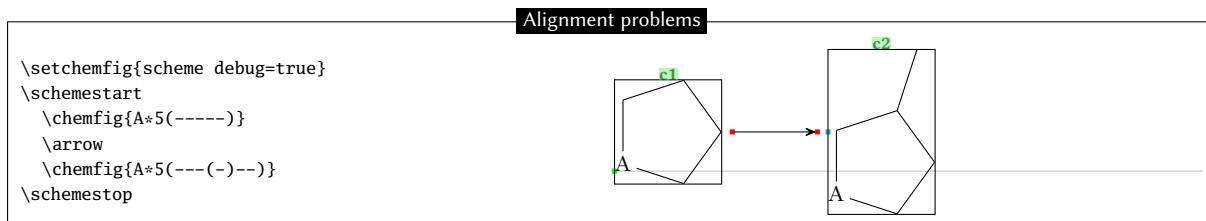

For the alignment to be correct, arrows will leave/arrive either from the anchor “base east”/“base west”, or from anchor “mid east”/“mid west”:

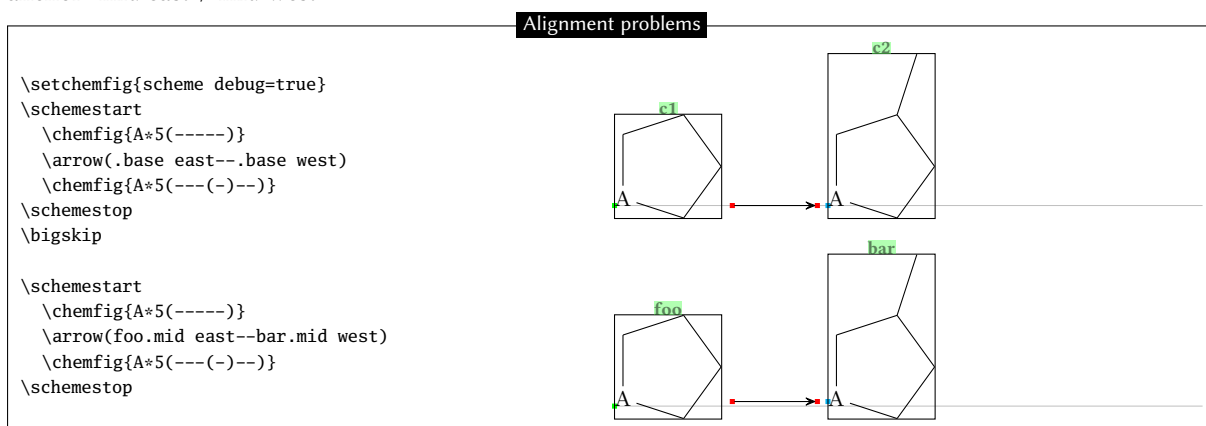

One last anchor need be specified: the anchor of the first compound with respect to the baseLine of the text just before it. This is illustrated by the green point on the left-hand side of the scheme below:

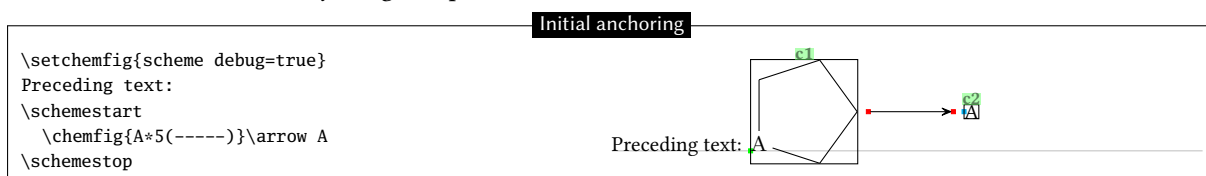

The default position of this anchor on the first compound’s bounding box is that given by “text”. This position can be controlled with the second optional argument of the \schemestart command:

Adjusting the initial anchoring

```
\setchemfig{scheme debug=true}
Preceding text:
\schemestart[][south]
  \chemfig{A*5(-----)}\arrow A
\schemestop
\bigskip

Preceding text:
\schemestart[][north west]
  \chemfig{A*5(-----)}\arrow A
\schemestop
\bigskip

Preceding text:
\schemestart[][west]
  \chemfig{A*5(-----)}\arrow A
\schemestop
```

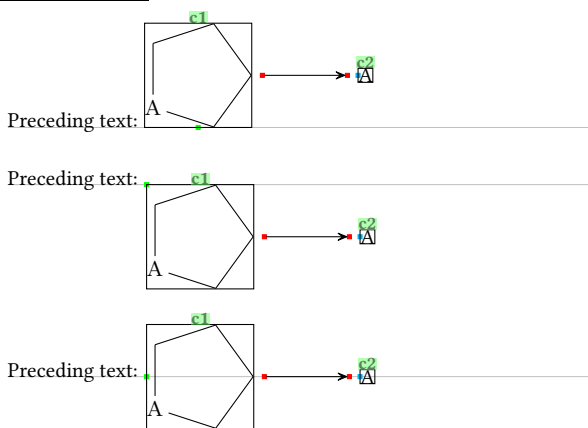

6 Compounds style

The `\arrow` command can also include `tikz` instructions to define the bounding box style “s” of the reactant and the product of the reaction. This is done with the argument between parentheses. Always style through the argument in brackets of the `\arrow`, we can specify with `tikz` instructions the style “s” to bounding box of the compound of departure or of arrival. Therefore the complete syntax of the `\arrow` command, with each specification being optional, is as follows:

$$\backslash\text{arrow}(n1.a1[s1]--n2.a2[s2])\{\text{arrow type}\}[\text{angle,coeff,arrow style}]$$

Like forn names, if specific styles are given to one compound by arrows arriving on it and leaving from it, the first style will be ignored with a warning.

Compounds style

```
\schemestart
  A
  \arrow([red]--[fill=blue,semitransparent,text opacity=1,
  inner sep=10pt,rounded corners=2mm])
  B
\schemestop
\bigskip

\schemestart
  A\arrow(--foo[yshift=5mm])B
\schemestop
```

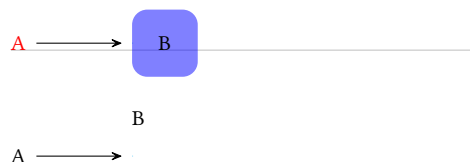

The macro `\setcompoundstyle{<code tikz>}` allows to globally define the style of compounds displayed thereafter. Entering an empty argument results in the absence of style, which corresponds to the default case.

Here a style is defined with round corner-shaped boxes and semitransparent background:

Global styles

```
\setchemfig{compound style={draw,line width=0.8pt,
semitransparent,text opacity=1,inner sep=8pt,
rounded corners=1mm}}
\schemestart
  A\arrow([fill=red]--[fill=blue])[90]
  B\arrow(--[fill=gray])
  C\arrow(--[fill=green])[-90]
  D\arrow(--[draw=none])[-180]
\schemestop
```

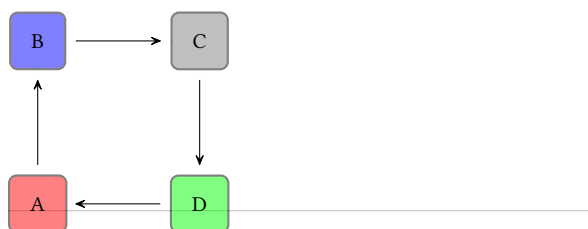

7 Branching

So far, only linear reaction schemes have been treated. Branched schemes are also possible and this is where compound names play a key role. When a name is preceded by “@” in the argument between brackets of the `\arrow` command, it means that the compound already exists. Several scenarios are possible:

- (@n1--n2): the arrow will leave from the existing compound “n1” and the scheme will continue following the arrow, thus creating a branch;
- (@n1--@n2): the arrow is drawn between two existing compounds, no matter whether they are already defined or whether they will later in the reaction scheme: therefore this syntax can be placed *anywhere* in the code of the reaction scheme;
- (n1--@n2): this syntax is not permitted;

In the following example, 3 branches are made, a first one from “B”, a second one from “D” and a last one from “X”. Finally one more arrow connects two existing compounds: “XX” and “D”:

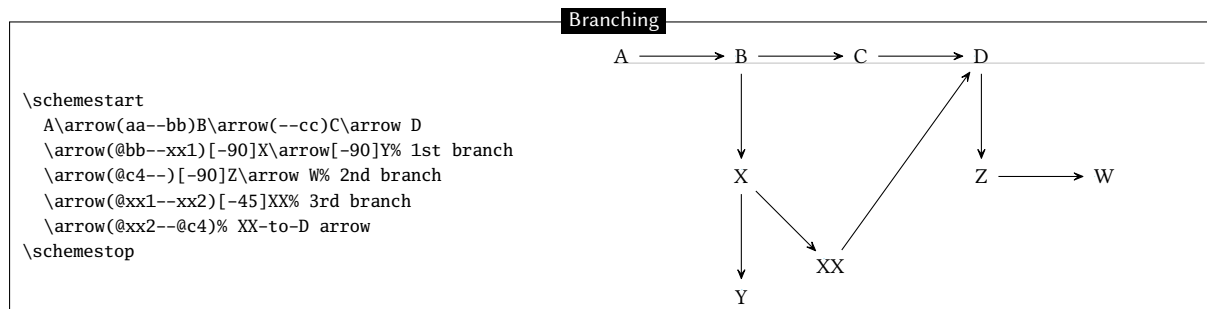

One may wish to have “Y” and “XX” on the same horizontal line. To achieve this, a horizontal invisible bond is drawn between “Y” and “XX”; the scheme is completed with a final arrow between the two existing compounds “XX” and “D”:

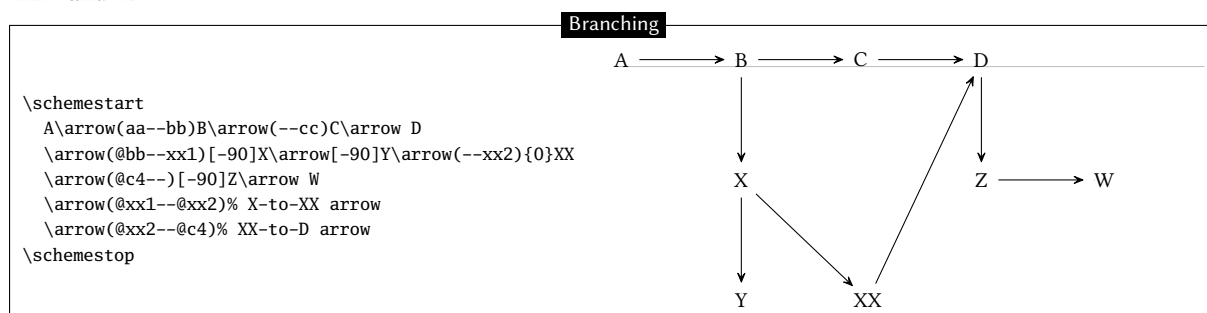

8 Subscheme

A fraction of the reaction scheme can be defined within a single bounding box, so that chemfig treats it as a compound. The reaction scheme fraction is defined inside the compulsory argument between braces of the `\subscheme` command so it is subsequently regarded as a single entity. When `\subscheme` is located after an arrow, the command labels this subscheme as a compound named “c<n+1>”:

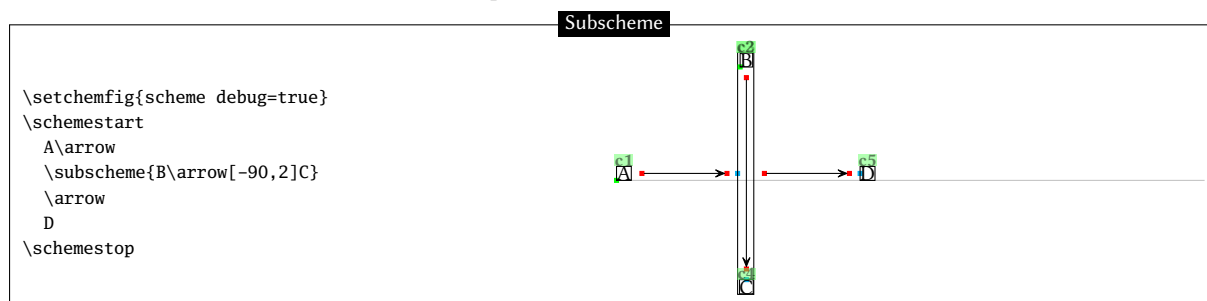

Although this is not clearly seen because of labels overlap, the box around the subscheme is called “c2”, and name numbering continues inside the subscheme with B called “c3” and C called “c4”. Since the first compound in the subscheme is “B”, the subscheme’s baseline is that of “B”. This can be pointed out by specifying the anchors:

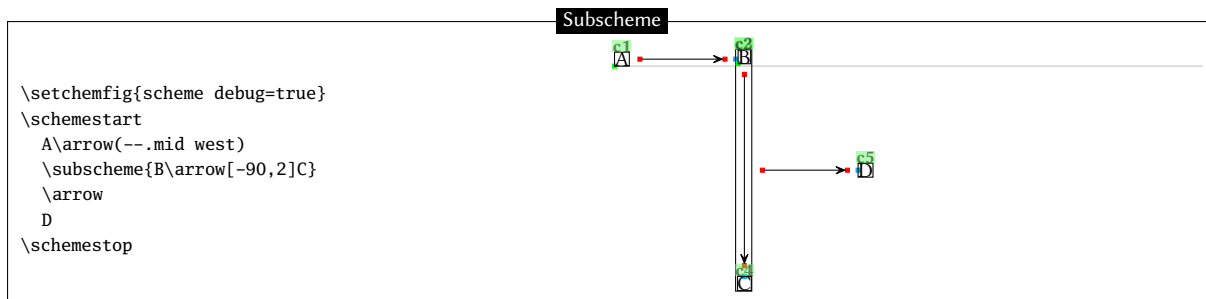

Note that since “`\subscheme{<scheme>}`” is only a convenient shortcut for

`\schemestart<scheme>\schemestop`

Consequently, it can be used with the same optional arguments as `\schemestart`.

`chemfig` provides the `\chemleft` and `\chemright` command pair. These allow to set expandable delimiters on either side of a material. The commands must be followed by delimiters, just like in the case of \TeX primitive commands `\left` and `\right`:

`\chemleft<car1><material>\chemright<car2>`

where `<car1>` and `<car2>` can be “(” et “)” or “[” and “]”, or any other expandable delimiter consistent with the `\left` et `\right` commands.

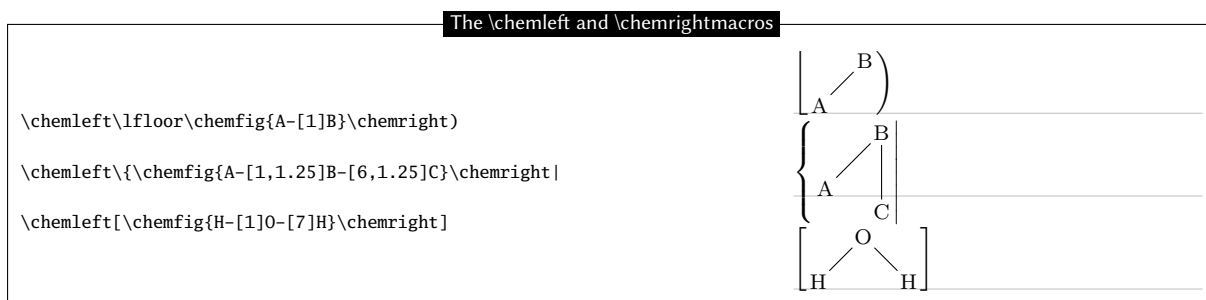

The code of the reaction scheme discussed above including `\chemleft` and `\chemright` is written:

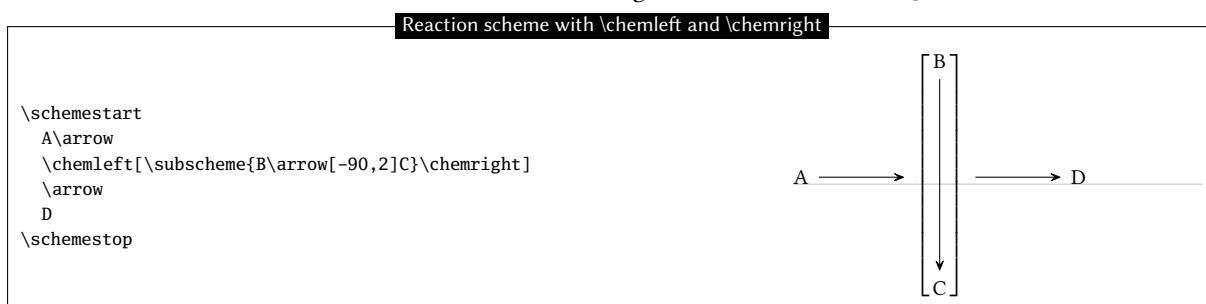

By analogy, the macros `\chemup` and `\chemdown` can be used to draw expandable delimiters above and below the material, respectively:

`\chemup<car1><material>\chemdown<car2>`

For example:

The `\chemup` and `\chemdown` macros

```
\schemestart[-90]
X\arrow
\chemup{\chemfig{A-[1]B-[7]C}\chemdown\}
\arrow Y
\schemestop
\qqad
\schemestart[-90]
X\arrow
\chemup[\chemfig{A-[1]B-[7]C}\chemdown]
\arrow Y
\schemestop
```

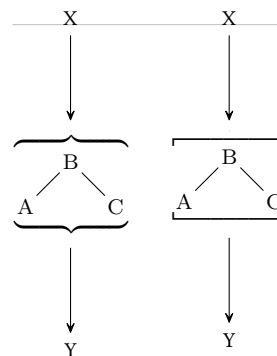

Delimiters can also be drawn through compounds' style and apply them to a random compound (and hereby to a subscheme). These expandable delimiters (parentheses, brackets, braces) can be used upon loading the "matrix" tikz library in the document preamble:

```
\usetikzlibrary{matrix}
```

Since the `\chemleft`, `\chemright`, `\chemup` and `\chemdown` commands are available, the `chemfig` package will *not* automatically load the library. As long as the user want to access this special set of delimiters, the library must be explicitly loaded.

The same brackets-delimited subscheme as above is presented again:

The "matrix" library delimiters

```
\schemestart
A\arrow(--[left delimiter={[, right delimiter={]})
\subscheme{B\arrow[-90,2]C}
\arrow
D
\schemestop
```

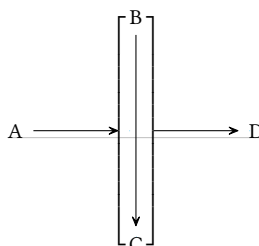

Since the delimiters are drawn outside the bounding box, it is advisable to slightly shorten the incoming and outgoing arrows:

Subscheme

```
\schemestart
A\arrow(--[left delimiter={[, right delimiter={]})[, ,shorten >=6pt]
\subscheme{B\arrow[-90,2]C}
\arrow[, ,shorten <=6pt]
D
\schemestop
```

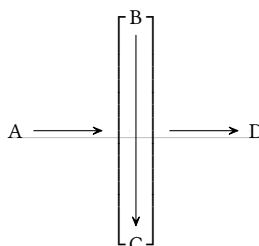

Subschemes should be used with care, undesired results are sometimes observed. In this example, a subscheme is used to horizontally align 3 different compounds:

Subscheme

```
\setchemfig{scheme debug=true}
\schemestart
A
\arrow{0}[-90]
\subscheme{%
tagada\arrow{}
tsoin\arrow{}
fin}
\arrow{xx--yy}{E}
\arrow{@c1--@c3}{E}
\arrow{@c1--@c5}{E}
\arrow{@c1--@c4}{E}
\schemestop
```

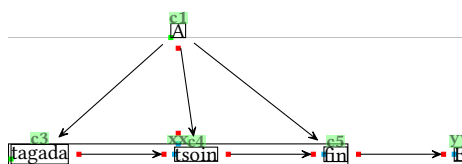

The center of the subscheme is exactly located on the same vertical line as the center of compound "A". This is because the two entities are connected by an invisible arrow with a -90 angle. However, the arrow between the two pre-existing compounds "A" and "tsoin" is *not* vertical because "tsoin" is not on the center of the subscheme since "tagada" is wider than "end". If this arrow is to be vertical within the use of the `\subscheme` command, one must find a correct angle for the arrival anchor of the invisible arrow by try-and-error.

A much simpler method is to use a branch instead of a subscheme: draw a *visible* arrow between "A" and "tsoin", and then draw horizontal arrows on both sides of "tsoin", with a branch for the right-hand side arrows.

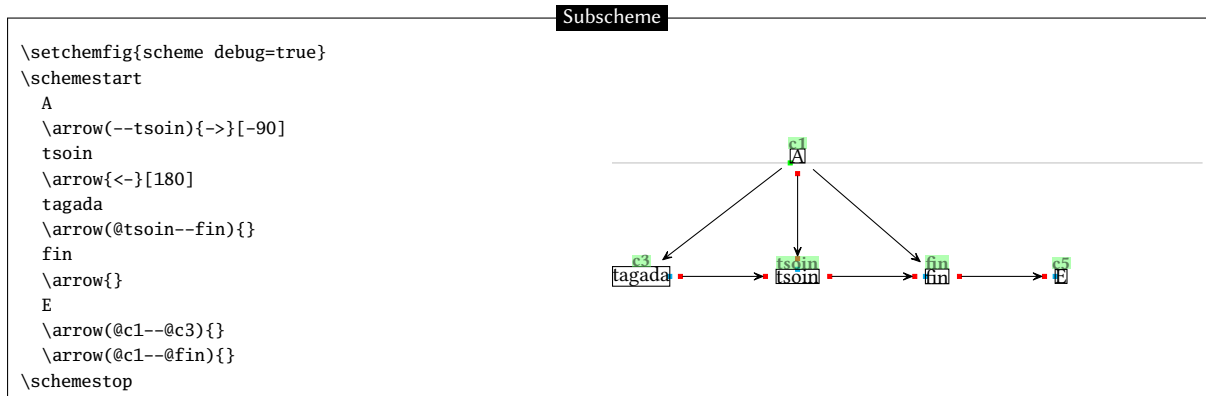

9 Arrows optional arguments

Within the argument in braces of the `\arrowcommand`, the arrow name can be followed by optional arguments written between brackets. Here are the possible values for these optional arguments and their meaning, as defined by `chemfig`:

- the arrows “ \rightarrow ”, “ \leftarrow ”, “ \leftrightarrow ”, “ \Leftrightarrow ”, “ \Leftrightarrow ”, “ \Leftrightarrow ”, “ \rightarrow ” have three optional arguments:
 - the first one contains the “label” to be placed above the arrow;
 - the second one contains the “label” to be placed below the arrow. The orientation of these two labels is given by the same angle as the arrow. The perpendicular shift between the arrow and the label anchor can be adjusted with the *key* `arrow label sep = <dim>` which value is 3pt by default. Labels contained in the two optional arguments are *not* typed in math mode.
 - the third one is a dimension corresponding to a shift perpendicular to the arrow that can be applied to it: the dimension is positive for an upward shift of the arrow (and of its labels, if any), and negative for a downward shift.
- the “ \curvearrowright ” arrow has 5 optional arguments:
 - the first three are identical to those found in the other arrow types;
 - the fourth one is a coefficient (which is 0.333 by default) which multiplies the length of the arrow to get the radius of the arc;
 - the fifth one is the half-angle from the center of the arc path, it is 60 degrees by default.
- the invisible arrow “ \rightarrow ” accepts two optional arguments of the same type as the first two listed above;

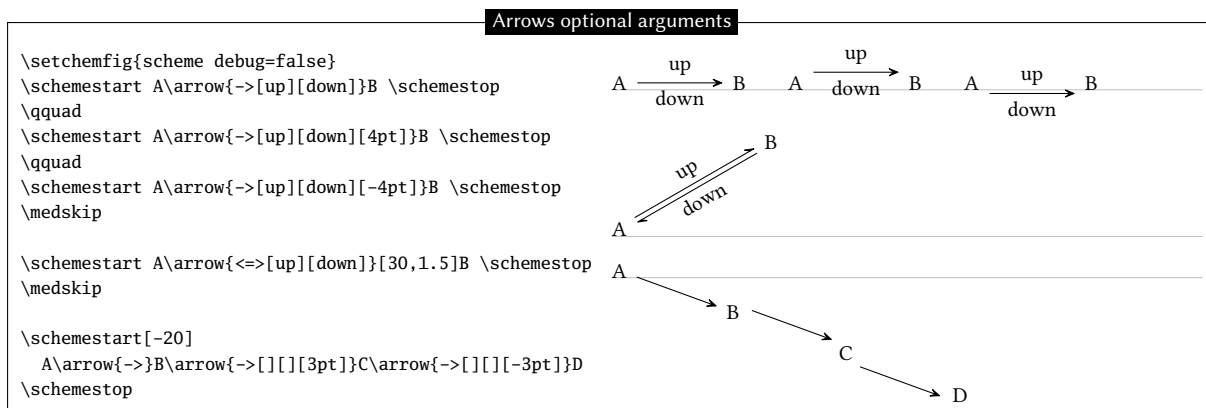

A problem arises for vertical arrows:

Vertical arrows

```
\schemestart
A\arrow{->[up][down]}[-90]B
\schemestop
```

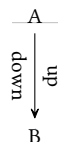

For the sake of clarity, one may prefer to have the “above” and “below” labels written horizontally. Label angles can be specified, while default is the same angle as that of the arrow. To choose a specific angle, $\ast\langle angle \rangle$ can be written at the beginning of the optional arguments:

Choice of angles

```
\setchemfig{scheme debug=true}
\schemestart A\arrow{->[*{0}up][*{0}down]}[90]B\schemestop
\qqquad
\schemestart A\arrow{->[*{0}up][*{0}down]}[45]B\schemestop
\qqquad
\schemestart A\arrow{->[*{0}up][*{0}down]}[-45]B\schemestop
\qqquad
\schemestart A\arrow{->[*{0}up][*{0}down]}[-90]B\schemestop
```

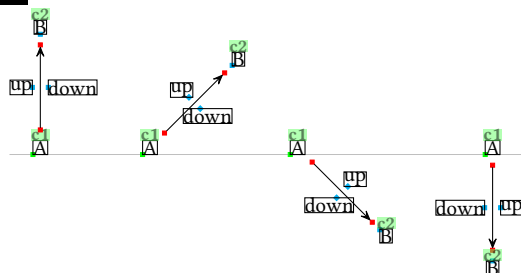

The default position of the label anchor can lead to undesired results:

Anchors

```
\setchemfig{scheme debug=true}
\schemestart
A\arrow{->[*{0}on top of][*{0}underneath]}[45,2]B
\schemestop
```

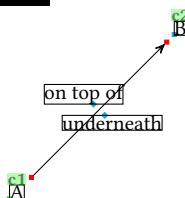

To counter this, the anchoring position can be specified as well to override the one selected by chemfig by default. The syntax for this is: $\ast\langle angle \rangle.\langle ancre \rangle$.

Anchors

```
\setchemfig{scheme debug=true}
\schemestart
A\arrow{->[*{0.0}on top of][*{0.180}underneath]}[45,2]B
\schemestop
\qqquad
\schemestart
A\arrow{->[*{0.south east}on top of][*{0.north west}underneath]}[45,2]B
\schemestop
```

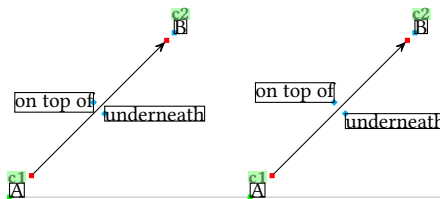

The “-U>” arrow remains a particular case. If one of the two labels from the first two optional arguments is present, the corresponding arc is plotted:

The -U> arrow

```
\schemestart A\arrow{-U>[123][456]}B\schemestop
\qqquad
\schemestart A\arrow{-U>[123]}[30]B\schemestop
\qqquad
\schemestart A\arrow{-U>}[456][30]B\schemestop
```

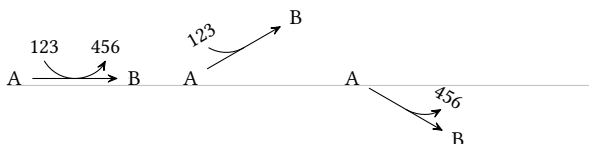

The fourth and fifth optional arguments modify the appearance of the arc: respectively the arrow length coefficient which sets the arc radius, and the angle that defines the half arc:

The -U> arrow

```
\schemestart A\arrow{-U>[123][456][][0.25]}B\schemestop
\qqquad
\schemestart A\arrow{-U>[123][456][][90]}B\schemestop
\qqquad
\schemestart A\arrow{-U>[123][456][1][45]}B\schemestop
```

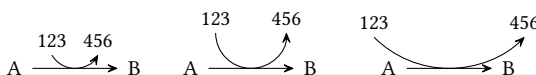

With negative values for the radius and the angle, the arc is drawn below the arrow:

The -U> arrow	
<pre>\schemestart A\arrow{-U>[123][456][[-0.333][[-60]]}B \schemestop</pre>	

Label angles and anchoring customization is controlled with the first two arguments, just like for other arrows:

The -U> arrow	
<pre>\schemestart A\arrow{-U>[123][456]}[-90]B \schemestop \qqquad \schemestart A\arrow{-U>[*{0.180}123][*{0.180}456]}[-90]B \schemestop</pre>	

10 Arrows customization

This section is quite technical and requires some knowledge of `tikz`. It is targeted at advanced users only who need to define their own arrows.

The `\definearrow` command allows to build custom arrows. Its syntax is:

$$\backslash\definearrow\langle number \rangle\{\langle arrow name \rangle\}\{\langle code \rangle\}$$

where $\langle number \rangle$ is the number of optional arguments that will be used in the $\langle code \rangle$, with the usual syntax #1, #2, etc. These optional arguments cannot accept default values; if no value is specified upon using the macro `\arrow`, the arguments will remain empty.

Before going further, let's examine the available internal macros when drawing arrows. Since these macros include the "@" character in their name, they can only be accessed between `\catcode'_ =11` and `\catcode'_ =8` commands.

- `\CF_arrowstartname` and `\CF_arrowendname` include the names of the compounds (considered as nodes by `tikz`) between which the arrow is drawn;
- `\CF_arrowstartnode` and `\CF_arrowendnode` include the node names where arrow ends will be located. After these names, user-defined anchors can be specified in the argument between brackets of the `\arrowcommand`, unless the field is left empty;
- `\CF_arrowcurrentstyle` and `\CF_arrowcurrentangle` contain the style and the angle of the arrow to be drawn;
- `\CF_arrowshiftnodes\langle dim \rangle` shifts the nodes "`\CF_arrowstartnode`" and "`\CF_arrowendnode`" perpendicularly relative to the arrow by a dimension specified in the argument;
- `\CF_arrowdisplaylabel\#1\#2\#3\#4\#5\#6\#7\#8` is the most complex one. It gives the labels position with the following arguments:
 - #1 and #5 are the labels to be written;
 - #2 and #6 are real numbers between 0 and 1. They specify the location of the labels on the arrow. 0 is the beginning of the arrow and 1 is its end, assuming a *straight* arrow;
 - #3 and #7 are the "+" or "-" characters. "+" displays the label above the arrow, while "-" does it below it;
 - #4 and #8 are the names of the nodes corresponding to the beginning and the end of the arrow.
- arrow heads are based on "CF" for a full arrow and have the "harpoon" option for half arrows.

10.1 First arrow

As an example, assume we want to make an arrow with a circle on its center. Let's call it "`-.>`". This arrow will accept four optional arguments. Like for previously-defined arrows, the first and second arguments will be the labels to be located above and below the arrow. The third one will define the perpendicular shift relative to the arrow direction. Finally, the 4th argument will define the circle size. If this last argument is absent the default circle size will be equal to 2pt.

Let's start with `\definearrow{4}{-.>}` to declare that the arrow will have 4 optional arguments and that it will be called `-.>`. First, the position of the nodes between which the arrow is to be drawn must be modified in order to take the third-argument shift into account. This is made with the macro `\CF_arrowshiftnodes`, so the code of the arrow will start with: `\CF_arrowshiftnodes{#3}%`. Then, one must plot the arrow itself, while taking the opportunity to set a node on the center of the segment, which will be called "mid@point". Finally, the circle is defined with its center on that node. The whole tikz code is:

```
\edef\pt_radius{\ifx\empty#4\empty 2pt\else #4\fi}% circle radius
\expandafter\draw\expandafter[\CF_arrowcurrentstyle,-CF]
(\CF_arrowstartnode)--(\CF_arrowendnode)coordinate[midway](mid@point);
\filldraw(mid@point)circle(\pt_radius);%
```

The last step is to enter the labels, if any, with the following line:

```
\CF_arrowdisplaylabel{#1}{0.5}{+}{\CF_arrowstartnode}{#2}{0.5}{-}{\CF_arrowendnode}
```

Here is the completed arrow:

Arrow "-.>"

```
\catcode'\_11
\definearrow4{-.>}{%
  \edef\pt_radius{\ifx\empty#4\empty 2pt\else #4\fi}% dot radius
  \CF_arrowshiftnodes{#3}%
  \expandafter\draw\expandafter[\CF_arrowcurrentstyle,-CF](\CF_arrowstartnode)--(\CF_arrowendnode)
  coordinate[midway](mid@point);
  \filldraw(mid@point)circle(\pt_radius);%
  \CF_arrowdisplaylabel{#1}{0.5}{+}{\CF_arrowstartnode}{#2}{0.5}{-}{\CF_arrowendnode}
}
\catcode'\_8
\schemestart
A \arrow{-.>} B \arrow{-.>[above][below][][1pt]} C \arrow{-.>[below]}{30} D \arrow{-.>[above][][5pt]}{1.5pt} E
\schemestop
```

10.2 Curved arrow

How about a curved arrow? To make things as simple as possible, assume it will have one single optional argument with the tikz code that will specify the point(s) of control. If this argument is empty, a “-CF” type arrow will be plotted.

If #1 is not empty, attention should not be drawn to “\CF_arrowstartnode” and “\CF_arrowendnode” which contain the node names of arrow ends positions, because the location of these nodes is already determined by the anchors calculated for *straight* arrows! Instead we will use `\CF_arrowstartname` and `\CF_arrowendname` which contain the names of the compound (which are nodes for tikz), since the arrow must be plotted between them. Here's the tikz code to draw the curved arrow between the two compounds:

```
\draw[shorten <=\CF_arrowoffset,shorten >=\CF_arrowoffset,\CF_arrowcurrentstyle,-CF,
(\CF_arrowstartname).. controls #1 ..(\CF_arrowendname)];%
```

One must add a tikz code to shorten the arrow by an amount `\CF_arrowoffset` defined by `\setarrowoffset`. Indeed, the nodes are not the same as those for straight arrows (`\CF_arrowstartnode` and `\CF_arrowendnode`). So before `\CF_arrowcurrentstyle`, the following code must be added:

```
shorten <=\CF_arrowoffset, shorten >=\CF_arrowoffset
```

this is the role the two lines after `\else`.

So here is our curved arrow:

Curved arrow

```

\catcode'\_11
\definearrow1{s>}{%
\ifx\empty#1\empty
\expandafter\draw\expandafter[\CF_arrowcurrentstyle,-CF](\CF_arrowstartnode)--(\CF_arrowendnode);%
\else
\def\curvedarrow_style{shorten <=\CF_arrowoffset,shorten >=\CF_arrowoffset,}%
\CF_eaddtomacro\curvedarrow_style\CF_arrowcurrentstyle
\expandafter\draw\expandafter[\curvedarrow_style,-CF](\CF_arrowstartname)..controls#1..(\CF_arrowendname);
\fi
}
\catcode'\_8
\schemestart
A\arrow{s>}
B\arrow{s>[+(0.5cm,0.5cm)]}
C\arrow{s>[+(45:1cm)]}
D\arrow(.60--.120){s>[+(60:1cm) and +(-120:1cm)]}
E\arrow{s>[+(45:1) and +(-135:1)]}
F\arrow{s>[+(-30:1) and +(150:1)]}[.1,1.5]
G\arrow(.90--.90){s>[+(60:1)and+(120:1)]}[.2]
H
\schemestop

\schemestart
A\arrow(.90--.180){s>[+(90:0.8) and +(180:0.8)]}[45]B
\arrow(.0--.90){s>[+(0:0.8) and +(90:0.8)]}[-45]C
\arrow(.90--.0){s>[+(-90:0.8) and +(0:0.8)]}[-135]D
\arrow(.180--.90){s>[+(180:0.8) and +(-90:0.8)]}[135]
\schemestop

```

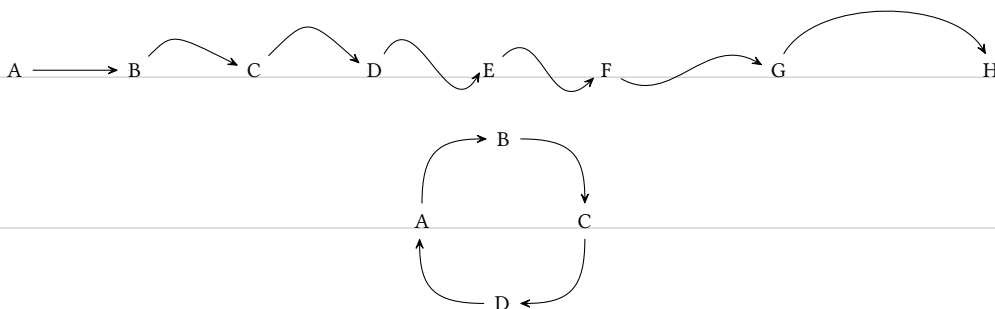

11 The `\merge` command

The `\merge` command allows to draw arrows coming from several existing compounds that merge into one single arrow that arrive to one single compounds.

Just after the `\merge` command, the direction that follows up must be specified. For this, 4 different direction characters can be used: “>” (the default direction if no character is entered), “<”, “^” and “v”.

The syntax follows with:

$$\backslash\text{merge}\{\text{dir}\}(n1.a1)(n2.a2)(\dots)(ni.ai)--(n.a[s])$$

where the “ni” names before the double dash are those already-defined compounds from which out coming arrows will merge into a single one. One can also specify the “ai” anchor, when the default one is not convenient. Like for the `\arrowcommand`, the command “n.a[s]” includes the name, the anchor and the style of the target compound.

The \mergecommand

```

\schemestart
ABC\arrow[30]EFGHIJ\arrow[45]KLM\arrow[60]NO
\merge>(c1)(c2)(c3)--()series 1
\arrow series 2
\schemestop
\bigskip
\schemestart
Fofoo\arrow(fooo--bar){<=>}Bar\arrow(--baz){<=>}Bz
\merge^(foo)(bar)(baz)--()series
\schemestop
\bigskip
\setchemfig{scheme debug=true}
\schemestart
A\arrow{<->}[90]B
\merge<(c1.120)(c2)--(foobar.45[circle,blue])CCC
\schemestop

```

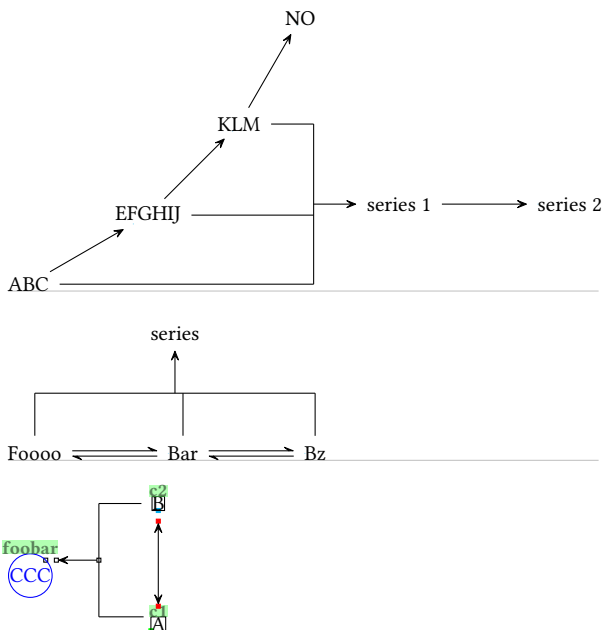

Regarding the geometry of the `\merge` arrow, it consists of n segments leaving from n compounds up to the perpendicular line that connects them: the default length of the shortest of these segments is worth half of the compound-spacing distance defined by `\setcompoundsep`. The arrow drawn from the connecting line to the target compound has the same default length, its origin is on the middle of the connecting line. These three geometric features can be customized with the optional argument immediately after the target compound:

$$\backslash\text{merge}\{\text{dir}\}(n1.a1)(n2.a2)(\dots)(ni.ai)--(n.a[s])[c1,c2,c,\text{style}]$$

where:

- the shortest segment distance between reactants and the connecting line is controlled through the multiplication of the `\setcompoundsep` distance by a coefficient `c1`, whose default value is 0.5;
- the length of the arrow between the connecting line and the product compound is controlled through the multiplication of the `\setcompoundsep` distance by a coefficient `c2`, whose default value is 0.5;
- the origin of the arrow between the connecting line and the product compound is determined by the coefficient `c`, a value of 0 involves a departure from the left of the connect line (or from its top if the direction is `v` or `^`);
- the style of the `\merge` arrow is defined with the last argument: `style`.

Geometrical parameters of \merge

```

\schemestart A\arrow{<=>}[90]B\merge(c1)(c2)--()C\schemestop\quad
\schemestart A\arrow{<=>}[90]B\merge(c1)(c2)--()[1]C\schemestop\quad
\schemestart A\arrow{<=>}[90]B\merge(c1)(c2)--()[,1]C\schemestop\quad
\schemestart A\arrow{<=>}[90]B\merge(c1)(c2)--()[,0.2]C\schemestop\quad
\schemestart A\arrow{<=>}[90]B\merge(c1)(c2)--()[,0.9,red,thick]C\schemestop
\bigskip

```

```

\schemestart A\arrow{<=>}B\merge^(c1)(c2)--()C\schemestop\quad
\schemestart A\arrow{<=>}B\merge^(c1)(c2)--()[1]C\schemestop\quad
\schemestart A\arrow{<=>}B\merge^(c1)(c2)--()[,1]C\schemestop\quad
\schemestart A\arrow{<=>}B\merge^(c1)(c2)--()[,0.2]C\schemestop\quad
\schemestart A\arrow{<=>}B\merge^(c1)(c2)--()[,0.9,red,thick]C\schemestop

```

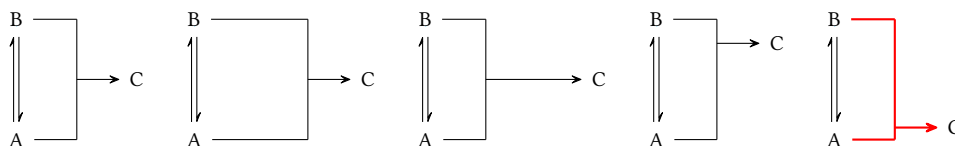

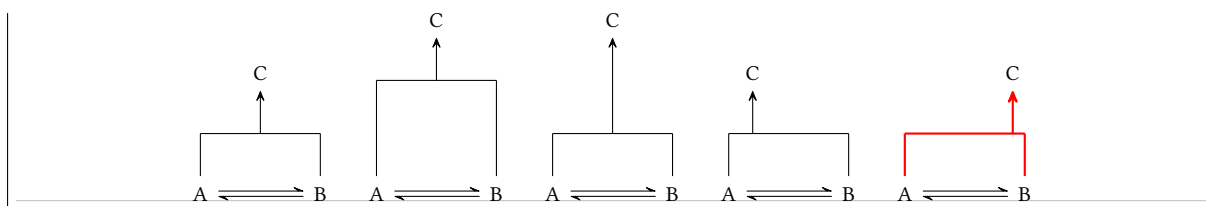

Finally, it is possible to write labels above or below the merged arrow. For this, the direction character accepts two optional arguments in brackets, a first one for the label above the arrow and a second one for the label below it. Therefore, the full syntax of the merge command is:

```
\merge{dir}[labelup][labeldown](n1.a1)(n2.a2)(...)(ni.ai)--(n.a[s])[c1,c2,c,style]
```

All the features introduced before for arrow labeling can be implemented here as well, i.e. rotation angle and anchoring with the syntax `*{angle.anchor}` entered just before the content of the label.

Labels of the \mergecommand

```
\schemestart
ABC\arrow{<=>}[90]DEF\merge>[above][below](c1)(c2)--()[0.25,1,0.75]GHIJ
\schemestop\qqquad
\schemestart
ABC\arrow{<=>}[90]DEF\merge>[*{45.south west}above][*{45.north east}below](c1)(c2)--()[0.25,1,0.75]GHIJ
\schemestop\qqquad
\schemestart
ABC\arrow{<=>}[90]DEF\merge>[*{90}above][*{90}below](c1)(c2)--()[0.25,1,0.75]GHIJ
\schemestop
\bigskip
\schemestart
ABC\arrow{<=>}DEF\merge v[above][below](c1)(c2)--()[0.25,1,0.75]GHIJ
\schemestop\qqquad
\schemestart
ABC\arrow{<=>}DEF\merge v[*{45.north west}above][*{45.south east}below](c1)(c2)--()[0.25,1,0.75]GHIJ
\schemestop\qqquad
\schemestart
ABC\arrow{<=>}DEF\merge v[*{0}above][*{0}below](c1)(c2)--()[0.25,1,0.75]GHIJ
\schemestop
```

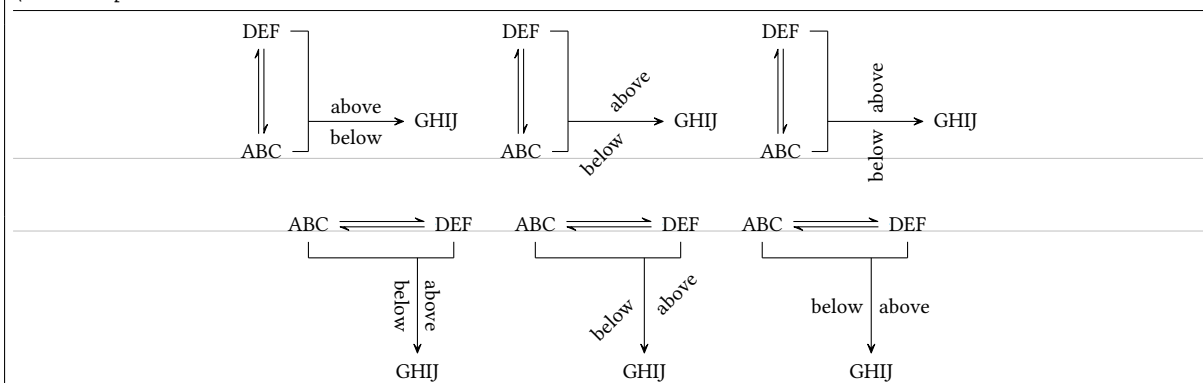

12 The + sign

The use of a “+” macro that displays a + sign is available between the commands `\schemestart` and `\schemestop`. This macro accepts an optional argument in braces with 3 dimensions in the form `{⟨dim1⟩,⟨dim2⟩,⟨dim3⟩}`, where:

- `⟨dim1⟩` and `⟨dim2⟩` are the dimensions to be inserted before and after the + sign;
- `⟨dim3⟩` is the vertical offset of the sign.

These dimensions can also be set, for all the following + signs with the `⟨keys⟩ + sep left = ⟨dim⟩`, `+ sep right = ⟨dim⟩` et `+ vshift = ⟨dim⟩`. The default values are 0.5em for the two first and 0pt for the third.

The \+ command

```
\schemestart
A\+B\+{2em,,5pt}C\+{0pt,0pt,-5pt}D\arrow E\+F
\schemestop

\setchemfig{+ sep left=1em,+ sep right=1em,+ vshift=0pt}
\schemestart
A\+B\+{2em,,5pt}C\+{0pt,0pt,-5pt}D\arrow E\+F
\schemestop
```

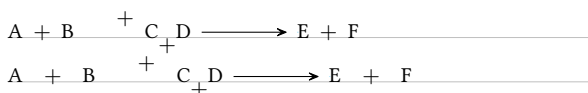

As shown in the example below, it should be kept in mind that the + sign inserted by the \+ command is part of the compound:

Compounds and \+

```
\setchemfig{scheme debug=true}
\schemestart A\+ B\+{,,5pt}C\arrow D\+ E\schemestop
```



This makes it difficult to draw a vertical arrow exactly below the letter “A” since this letter is not a single compound for chemfig. This issue can be solved with the use of the \subscheme command to uniquely define the letter “A” as a single compound (the same procedure can be applied to the + sign itself) so that it can be referred to later on with its own name:

Subcompound and \+

```
\setchemfig{scheme debug=true}
\schemestart
\subscheme{A}\+ B\arrow C
\arrow{@c2--}[-90]E
\schemestop
\medskip
\schemestart
A\subscheme{\+}BCDEF \arrow G
\arrow{@c2--}[-90]H
\schemestop
```

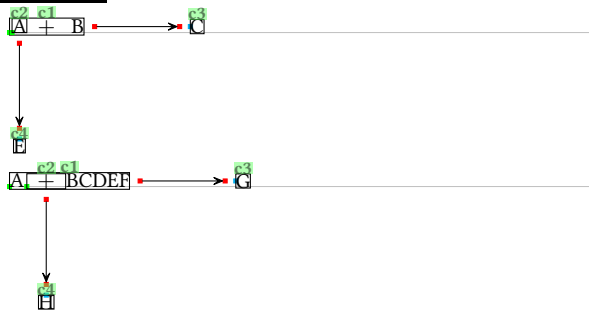

A common problem can be the misalignment of the “+” sign with the molecules before or after it. For example:

+ sign alignment

```
\setchemfig{scheme debug=true}
\schemestart
\chemfig{C(<[:40])(<[:160])=[6]C(<[:130])<[:20]}
\+
\chemfig{\charge{90=\|,180=\|,270=\|}{Br}-\charge{0=\|,90=\|,-90=\|}{Br}}
\schemestop
```

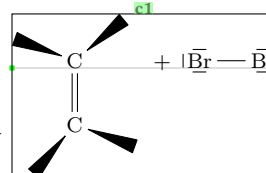

Here, the “+” sign sits on the same baseline as the compound before it, and this baseline is that of the top carbon atom. One may shift the “+” sign, but this would not change the vertical position of “|Br — Br|”. In fact, the “+” sign does not prevent chemfig from reading a compound, as shown in the example above where everything is included in the compound “c1”. Therefore, one must stop the compound right after the first molecule with a \arrow{0}[,0] that will draw an invisible, zero-length arrow. In order to vertically center the whole scheme, one must also set the the anchor of the first compound as “west” (or “180”, which is a synonym) with the second optional argument of the \schemestart command:

+ sign alignment

```
\setchemfig{scheme debug=true}
\schemestart[][west]
\chemfig{C(<[:40])(<[:160])=[6]C(<[:130])<[:20]}
\arrow{0}[,0]\+
\chemfig{\charge{90=\|,180=\|,270=\|}{Br}-\charge{0=\|,90=\|,-90=\|}{Br}}
\schemestop
```

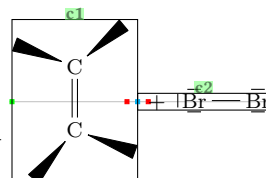

Thus, the first compound “c1” consists of the first molecule and the second compound consists of everything else, i.e. the “+” sign and the second molecule. Alternatively, one can play with anchors or styles via the \arrow command to move the second compound to another location. Here, for example, the second compound is shifted downwards by 10pt in the first case. In the second case, the “south east” anchor of the first compound matches the “south west” anchor of the second one:

+ sign alignment

```
\setchemfig{scheme debug=true}  
\schemestart[][west]  
\chemfig{C(<[:40])<[:160])=[6]C<[:-130])<[: -20]}  
\arrow(--[yshift=-10pt]){0}[,0]\+  
\chemfig{\charge{90=\|,180=\|,270=\|}{Br}-\charge{0=\|,90=\|,-90=\|}{Br}}  
\schemestop  
\medskip
```

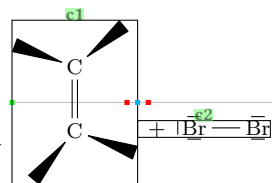

```
\schemestart[][west]  
\chemfig{C(<[:40])<[:160])=[6]C<[:-130])<[: -20]}  
\arrow(.south east--.south west){0}[,0]\+  
\chemfig{\charge{90=\|,180=\|,270=\|}{Br}-\charge{0=\|,90=\|,-90=\|}{Br}}  
\schemestop
```

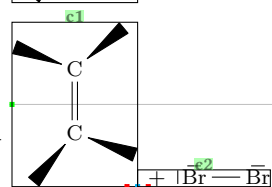

List of commands

The commands created by chemfig are:

Commands	Description
<code>\chemfig[⟨settings⟩]{⟨code⟩}</code> <code>\setchemfig{⟨settings⟩}</code>	draws the molecule whose design is described by the <code>⟨code⟩</code> sets the parameters with the syntax <code>⟨key⟩ = ⟨value⟩</code> . Here is the full list of keys with the default values: <ul style="list-style-type: none"><code>chemfig style = ⟨⟩</code>: style given to tikz<code>atom style = ⟨⟩</code>: style of tikz nodes (atoms)<code>bond join = ⟨false⟩</code>: boolean for bond joins<code>fixed length = ⟨false⟩</code>: boolean for fixed bond widths<code>cram rectangle = ⟨false⟩</code>: boolean to draw rectangle Cram bond<code>cram width = ⟨1.5ex⟩</code>: length of the base of the triangles Cram bonds<code>cram dash width = ⟨1pt⟩</code>: width of dash Cram bonds<code>cram dash sep = ⟨2pt⟩</code>: space between dash Cram bonds<code>atom sep = ⟨3em⟩</code>: space between atoms<code>bond offset = ⟨2pt⟩</code>: space between atom and bond<code>double bond sep = ⟨2pt⟩</code>: space between multiple bonds lines<code>angle increment = ⟨45⟩</code>: increment of the angle of bonds<code>node style = ⟨⟩</code>: style of atoms<code>bond style = ⟨⟩</code>: style of bonds<code>lewis width = ⟨0.3ex⟩</code>: width of the rectangle Lewis " "<code>lewis sep = ⟨0.4ex⟩</code>: space between atom and Lewis formulas<code>lewis length = ⟨1.5ex⟩</code>: length of Lewis formulas<code>lewis style = ⟨⟩</code>: style of Lewis formulas<code>lewis dist = ⟨0.3em⟩</code>: space between discs of the ":" Lewis formulas<code>lewis radius = ⟨0.15ex⟩</code>: radius of discs for Lewis formulas<code>lewis diag coeff = ⟨1⟩</code>: factor that multiplies the distance to Lewis formulas in odd directions<code>cycle radius coeff = ⟨0.75⟩</code>: shrinkage ratio of the circle or arc inside cycles<code>stack sep = ⟨1.5pt⟩</code>: vertical gap between arguments of <code>\chemabove</code> and <code>\chembelow</code> macros<code>compound style = ⟨⟩</code>: style of compounds<code>compound sep = ⟨5em⟩</code>: space between compounds<code>arrow offset = ⟨4pt⟩</code>: space between compound and arrow<code>arrow angle = ⟨0⟩</code>: angle of the reaction arrow<code>arrow coeff = ⟨1⟩</code>: length ratio of arrows<code>arrow style = ⟨⟩</code>: style of arrows<code>arrow double sep = ⟨2pt⟩</code>: space between double arrows<code>arrow double coeff = ⟨0.6⟩</code>: shrinkage ratio for the little arrow in "<code><-></code>" and "<code><-></code>"<code>arrow double harpoon = ⟨true⟩</code>: boolean for double harpoon arrows<code>arrow label sep = ⟨3pt⟩</code>: space between arrow and its label<code>arrow head = ⟨-CF⟩</code>: style of arrow head<code>+ sep left = ⟨0.5em⟩</code>: space before the + sign<code>+ sep right = ⟨0.5em⟩</code>: space after the + sign<code>+ vshift = ⟨0pt⟩</code>: vertical shift of the + sign
<code>\resetchemfig</code>	Reset the parameters to their default values
<code>\printatom</code>	displays the atoms within the molecules. It can be redefined to customize the output. See page 25
<code>\hflipnext</code>	the next molecule will be horizontally flipped
<code>\vflipnext</code>	the next molecule will be vertically flipped
<code>\definesubmol{⟨name⟩}⟨n⟩[⟨code1⟩]{⟨code2⟩}</code>	creates an alias <code>!⟨name⟩</code> which can be put in the code of molecules to be drawn, and which will be replaced with <code>⟨code1⟩</code> or <code>⟨code2⟩</code> depending on the angle of the last bond. See page 27
<code>\chemskipalign</code>	tells the vertical alignment mechanism to ignore the current group of atoms. See page 31.

<code>\redefinesubmol{<name>}{<n>[<code1>]}{<code2>}</code>	replaces a preexisting alias !<name> with the new <code>. See page 28
<code>\charge{[<parameters>][<pos>][<tikz>]}{<atom>}</code>	prints <atome> and places the charges according to their <positions>. The charges are placed out of the bounding box of the <atome>. See page 32
<code>\Charge{[<parameters>][<pos>][<tikz>]}{<atom>}</code>	Same behaviour as \charge, but the final bounding box takes the charges into account.
<code>\chemmove[<tikz options>]{<tikz code>}</code>	Makes a tikzpicture environment, adding to it the <tikz options>. Uses the <tikz code> to join the nodes specified in the molecules with the help of the "@" character. See page 20.
<code>\chemabove[<dim>]{<txt1>}{<txt2>}</code>	writes <txt1> and places <txt2> above, leaving <dim> of vertical space. This command does not change the bounding box of <txt1>. See page 34
<code>\chembelow[<dim>]{<txt1>}{<txt2>}</code>	writes {txt1} and places <txt2> below, leaving <dim> of vertical space. This command does not change the bounding box of <txt1>. See page 34
<code>\Chemabove[<dim>]{<txt1>}{<txt2>}</code>	writes <txt1> and places <txt2> above, leaving <dim> of vertical space. See page 34
<code>\Chembelow[<dim>]{<txt1>}{<txt2>}</code>	writes {txt1} and places <txt2> below, leaving <dim> of vertical space. See page 34
<code>\chemname[<dim>]{<molecule>}{<name>}</code>	Places <name> under the <molecule>
<code>\chemnameinit</code>	Initializes the greatest molecule depth to ensure correct alignment of the names of the following molecules.
<code>\schemestart... \schemestop</code>	commands between which a reaction scheme is drawn. See page 48.
<code>\arrow</code>	draws an arrow in a reaction scheme (this command is only defined inside a reaction scheme). See page 48.
<code>\+</code>	prints a + sign in a reaction scheme (this command is only defined inside a reaction scheme). See page 62.
<code>\subscheme{<code>}</code>	draws a subscheme (this command is only defined inside a reaction scheme). See 53.
<code>\definearrow</code>	defines an arrow. See page 58.
<code>\chemleft<car1>{<stuff>}\chemright<car2></code>	draws expandable delimiters defined with <car1> and <car2> on the left and on the right of the <stuff>, see page 54.
<code>\chemup<car1>{<stuff>}\chemdown<car2></code>	draws expandable delimiters defined with <car1> and <car2> above and below the <stuff>, see page 54.
<code>\polymerdelim[<settings>]{<node1>}{<node2>}</code>	draws delimiters at specified nodes, see page 44

Gallery

This manual concludes with drawings of molecules of varying complexity.

The curious user can look at the *code* of each molecule, though it does become less attractive the more complex the molecule gets. Indeed, beyond a certain level of complexity, though it is fairly easy to write *code*, it becomes much harder to read the *code* to analyze it afterwards. We quickly reached the limits of immediate readability of the code of a complex drawing.

Anyway, I hope that this package will help all \LaTeX users wishing to draw molecules. Although `chemfig` has been thoroughly tested and although its version number is now greater than 1.0, I hope that you will be forgiving with bugs you encounter and send me an [email](#) to let me know of any malfunctions or suggestions for improvement.

Christian TELLECHEA

*
* *

2-methylpentane

```
\chemfig{[7]H_3C-CH(-[6]CH_3)-[1]CH_2-CH_2-[1]CH_3}
```

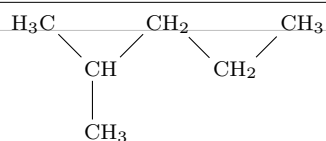

3-ethyl-2-methylhexane

```
\chemfig{H_3C-[7]CH(-[6]CH_3)-[1]CH(-[7]C_3H_7)-[2]CH_2-[3]H_3C}
```

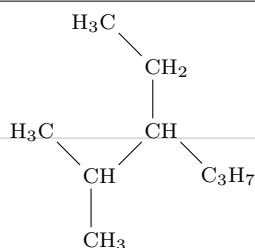

Stearine, condensed structural diagram

```
\definesubmol{@}{([0,2]-O-[0,1]C(=[2,1]O)-C_{17}H_{33})}  
\chemfig{[2,2]CH_2!@-CH_{\phantom 2}!@-CH_2!@}
```

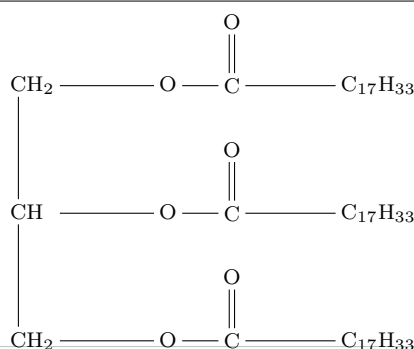

Stearine, skeleton diagram

```
\definesubmol{x}{-[:+30,.6]-[: -30,.6]}
\definesubmol{y}{-0-(=[2,.6]O)-!x!x!x!x!x!x!x}
\chemfig{[2]([0]!y)-[,1.5]([0]!y)-[,1.5]([0]!y)}
```

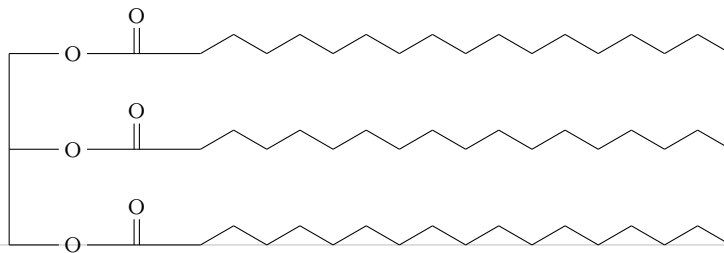

Methyl 2-methylpropanoate

```
\chemfig{H_3C-CH_2(-[2]CH_3)-C(=[1]O)-[7]O-CH_3}
```

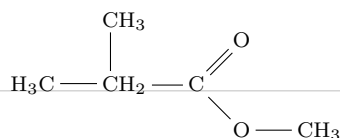

Vanillin

```
\chemfig{HC*6(-C(-OH)=C(-O-[: -60]CH_3)-CH=C(-[, , , 2]HC=[: -60]O)-HC=[: , 2])} \quad or \quad
\chemfig{*6(-(-OH)=(-OCH_3)-(-[: -60]O)-=)}
```

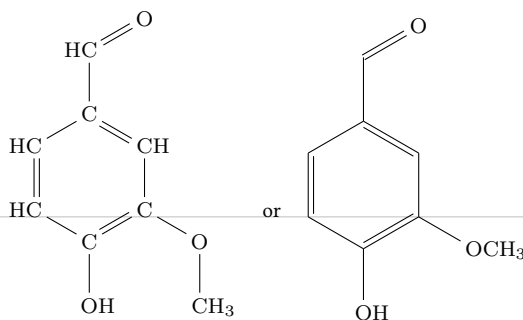

Caffeine

```
\chemfig{*6((=O)-N(-CH_3)-*5(-N=N(-CH_3)-=)--(=O)-N(-H_3C)-)}
```

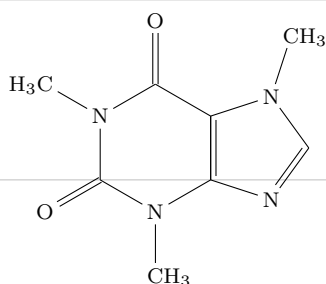

Aspirin

```
\chemfig{*6(=-(-O-[: -60])(=[: -60]O)-[: +60])=(-([: +60])-[: -60]OH)-=)}
```

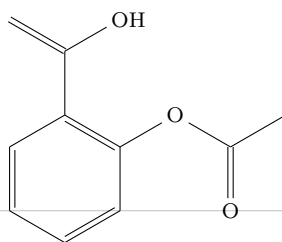

Aspirin is a registered trademark of Bayer in many countries.

Phthalic anhydride

```
\chemfig{*6(=*5(- (=O)-O(-=O)-)---)}
```

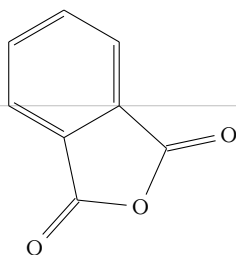

Camphor

```
\chemfig{*6(-(<[:120](-[: -100,0.7])(-[:100,0.7]))--(=O)-(-<[:120]--))}
\quad or \quad
\setchemfig{cram width=3pt}
\chemfig{<[:10](>[:85,1.8]?(-[:160,0.6])-[:20,0.6])
>[: -10]-[:60](=[:30,0.6]O)-[:170]?(-[:30,0.6])-[:190]-[:240]}
```

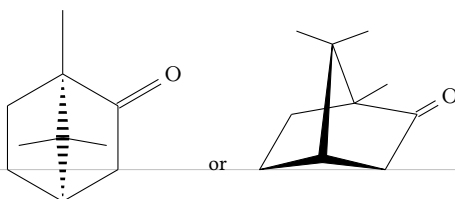

Triphenylmethane

```
\chemfig{*6(--*6(-(*6(-----))*6(-----))=--)}
\quad or \quad
\definesubmol{@}{*6(-----)}
\chemfig{(-[: -30]!@)(-[:90]!@)(-[:210]!@)}
```

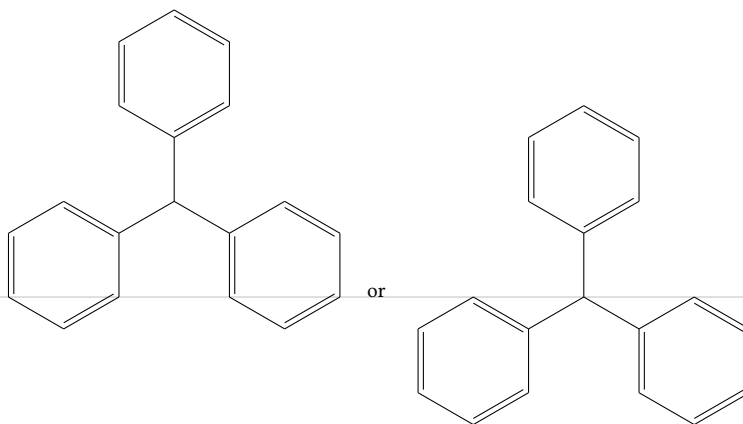

Amygdalin

```
\setchemfig{cram width=2pt}
\definesubmol{c1}{-[:200]-[:120]O-[:190]}
\definesubmol{c2}{-[:170](-[:200,0.7]HO)<[:300](-[:170,0.6]HO)
-[:10,,,line width=2pt](-[: -40,0.6]OH)>[: -10]}
\definesubmol{csub}{-[:155,0.65]-[:90,0.65]}
\chemfig{O(!{c1}(!{csub}O(!{c1}(!{csub}OH)!{c2}))!{c2})-[: -30](-[: -90]CN)-[:30]*6(-----)}
```

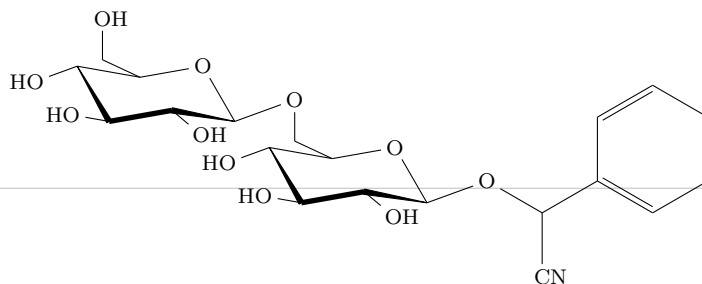

Adenosine triphosphate

```
\setchemfig{cram width=3pt}
\definesubmol{a}{-P(=[::-90,0.75]O)(-[::90,0.75]HO)-}
\chemfig{[: -54]*5(-[::60]O[:: -60]!aO[:: -60]!aO[::60]!aHO))<(-OH)
-[,,,line width=2pt](-OH)>(-N*5(-=N*6(-(-NH_2)=N=N-)=)-)-0-}
```

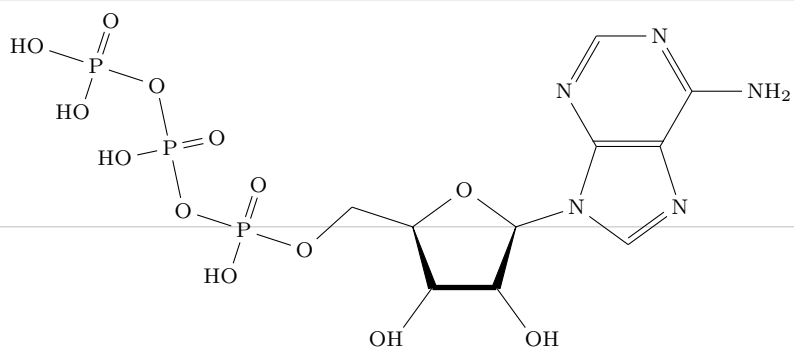

Viagra

```
\chemfig{N*6((-H_3C)---N(-S(=[::+120]O)(=[::+0]O)-[:: -60]*6(---(-O[:: -60]-[:: +60]CH_3)
=( -*6(N=*5(-(-[:: -60]-[:: +60]CH_3)=N-N(-CH_3)-=)--(=O)-N(-H)-))=))---)}
```

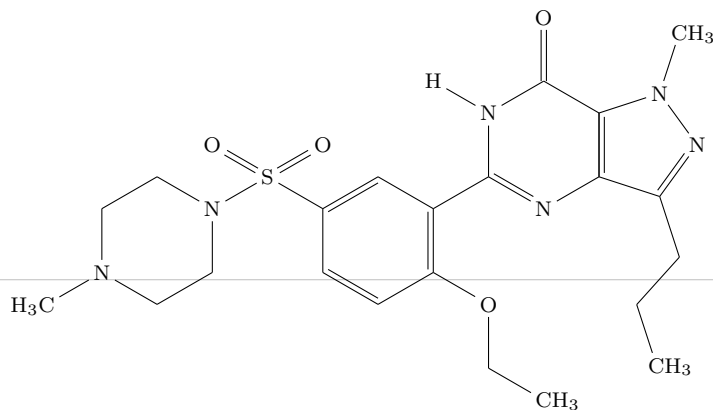

Cholesterol ester

```
\chemfig{[:30]R-(=[::+60]O)-[:: -60]O-*6(---6(---6(*5(---(-[:: +60]Me)
-[:: -60]-[:: -60]-[:: +60]-[:: -60](-[:: -60]Me)-[:: +60]Me)-)-(-[:: +0]Me)---))--(-[:: +0]Me)---)}
```

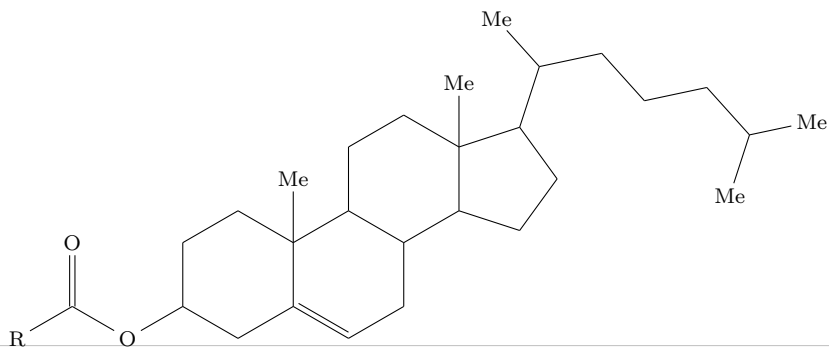

Porphyrin

```
\chemfig{?=[::+72]*5(-N(=[::-72]*5(-[,,,2]HN-[,,,2](-[:: -36]*5(N(=[::-72]*5(-NH-[,,,1]?=--))
--))--))--)}
```

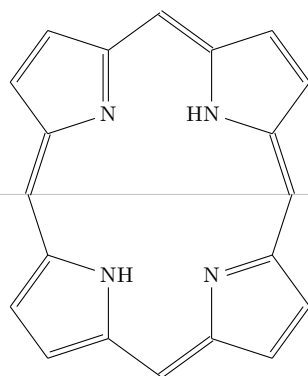

Manganese 5,10,15,20-tetra(N-ethyl-3-carbazolyl) porphyrin

```
\definesubmol{A}{*6(=*5(-*6(==--)--N(--[: -60])-==--)}
\chemfig{([: +180]-!A)=[: +72]*5(-N(-[: +54]!A)=[: -72]*5(-N(-[: -33,1.5,,draw=none]Mn)
-(=([-[: +72]!A)-[: -36]*5(=N(-[: +54]!A)-[: -72]*5(-N(-)=))=))=))=)}
```

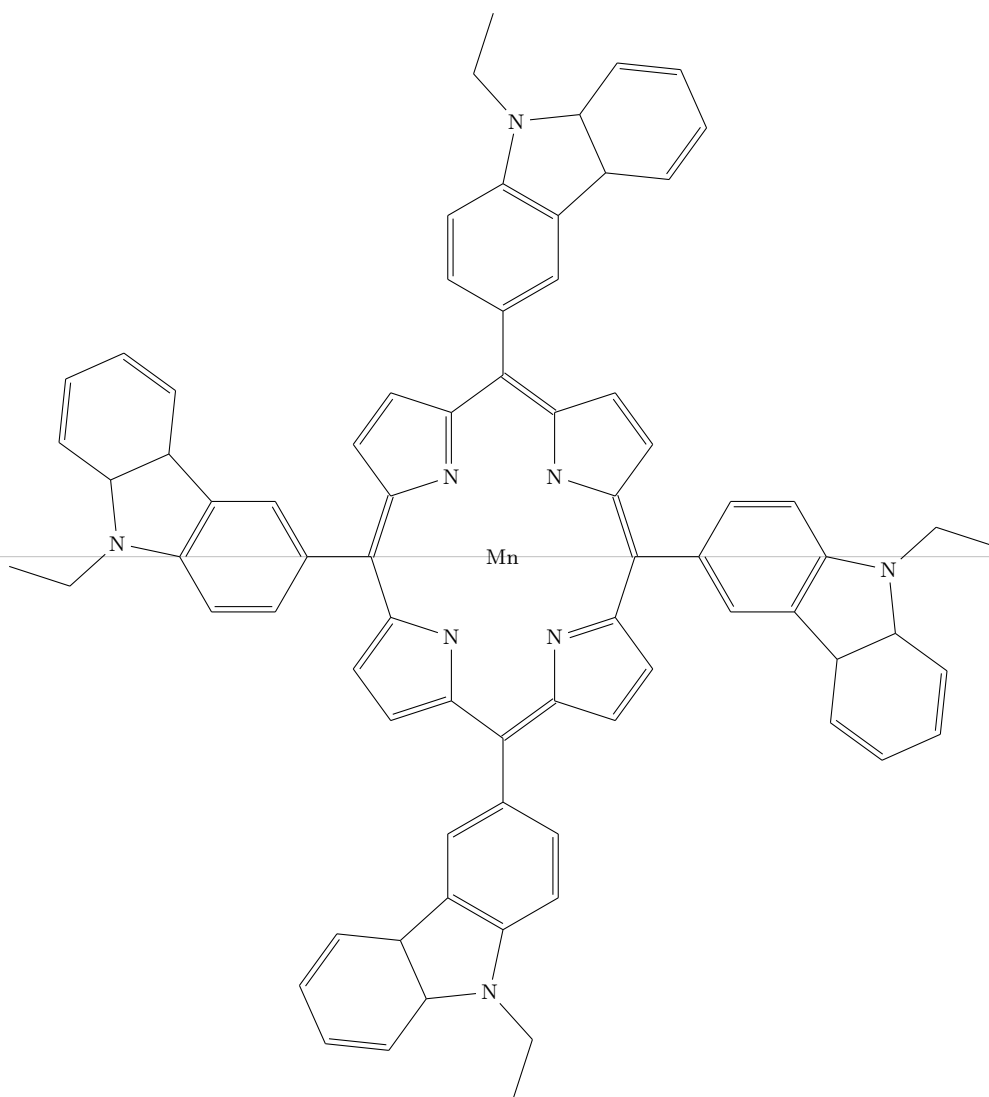

Penicillin

```
\chemfig{[: -90]HN(-[: -45](-[: -45]R)=[: +45]O)>[: +45]*4(- (=O)-N*5(- (<[: -60]O)
-[: +60]OH)-(<[: +0])(<[: -108])>-S>--)}
```

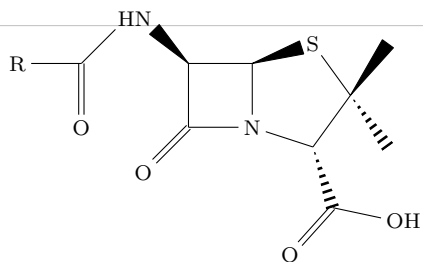
LSD

```
\chemfig{[:150]?*6(=*6(--*6(-N(-CH_3)--(<[::+60]O)-[: -60]N(-[:+60]-[: -60])
-[: -60]-[:+60])=)([: -120]<H)---)*6(---(-[: -30,1.155]\chembelow{N}{H}?=))}
```

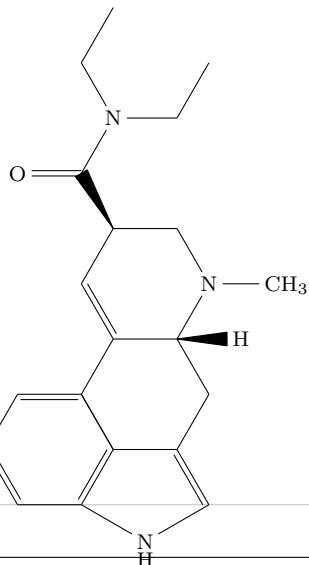

Strychnine

```
\chemfig{*6(=*6(-N*6(- (=O)--([: -120]<:H)*7(-0---?[0]([: -25.714]-[ ,2]?[1]))
-*6(-?[0, {>}]-(<N?[1]?[2])-(<[: -90]-[: -60]?[2]))(<[: +0]H)-([: +120]<H))--?)=?=-)}
```

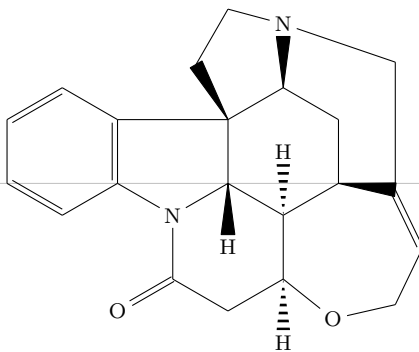

Codeine

```
\chemfig{[: -30]**6(-(-OH)-?*6(-(-[3]-[2,2]-[0, .5])*6(-<[: -150,1.155]0?)
-<[:OH])=)-<[:1]H)-(-[2]NCH_3)--)}\}
```

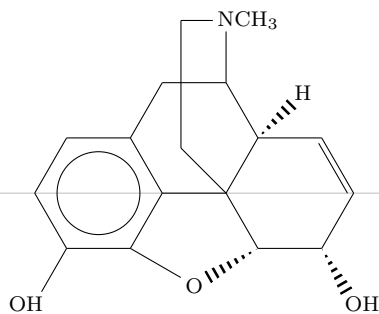

A dye (red)

```
\chemfig{*6(--*6(-(-NO_2)=(-\charge{90=\|,-90=\|}{0})-[0]H)=(-\charge{180=\|}{N}=[0]\charge{90=\|}{N}-[0]Ar)-----)}
```

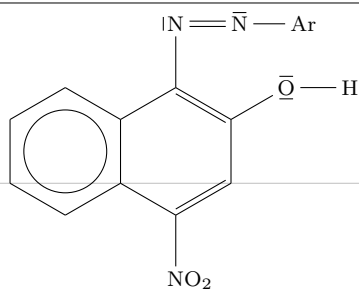
**Menthone**

```
\chemfig{CH_3-?(-[2]H)(-[: -30,2]-[: +60](=[1]\charge{0=\|,90=\|}{0})-[: -150,1.5](-[:20]CH(-[1]CH_3)(-[7]CH_3))(-[6]H)-[: -90,2]-[: +60]?)}
```

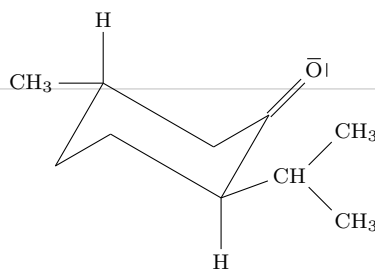
**Fullerene**

```
\definesubmol\fragment1{
(-[:#1,0.85,,draw=none]
-[::126]-[: -54](=_(2pt,2pt)[::180])
-[:: -70](-[: -56.2,1.07]=^#(2pt,2pt)[::180,1.07])
-[::110,0.6](-[: -148,0.60](=^[::180,0.35])-[:: -18,1.1])
-[::50,1.1](-[::18,0.60]=_[::180,0.35])
-[::50,0.6]
-[::110])
}
\chemfig{
!\fragment{18}
!\fragment{90}
!\fragment{162}
!\fragment{234}
!\fragment{306}
}
```

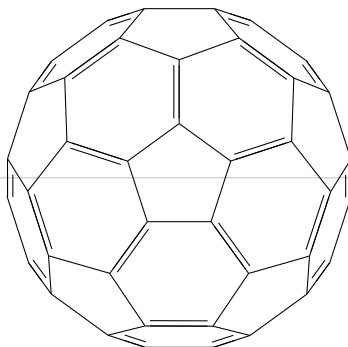
**Fischer indole synthesis**

```
\schemestart
\chemfig{*6(=*6(-\chembelow{N}{H}-NH_2)=-=)}
\+
\chemfig{(=[-150]0)(-[: -30]R_2)-[2]-[:150]R_1}
\arrow(.mid east--.mid west){->[\chemfig{H^+}]}
\chemfig{*6(=*5(-\chembelow{N}{H})-(-R_2)=(-R_1)-)=)}
\schemestop
```

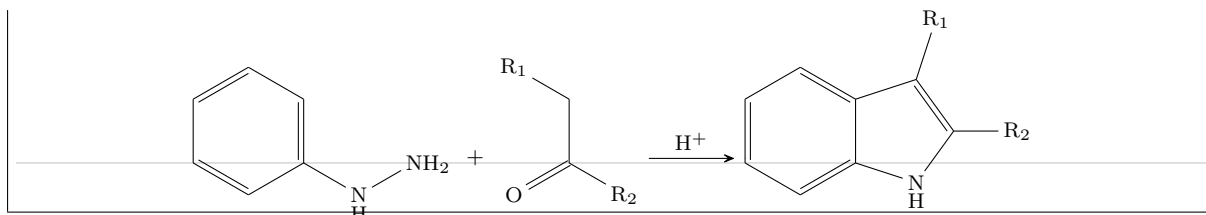

Reaction mechanisms: carbonyl group

```
\schemestart
\chemfig{C([3-])([5-])=[@{db},.5]{@atoo}\charge{0=\|,-90=\|}{0}}
\arrow(.mid east--.mid west){<->}
\chemfig{\charge{90:3pt=$\scriptstyle\oplus$}{C}([3-])([5-])-%
\charge{0=\|,90=\|,-90=\|,45:3pt=$\scriptstyle\ominus$}{0}}
\schemestop
\chemmove{\draw[shorten <=2pt, shorten >=2pt](db) ..controls +(up:5mm) and +(up:5mm)..(atoo);}
```

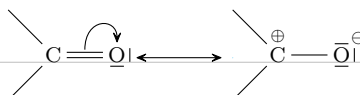

Reaction mechanisms: nitro group

```
\schemestart
\chemfig{R-\charge{225:3pt=$\scriptstyle\oplus$}{N}([1]=[@{db}]{@atoo1}O)([7]-[@{sb}]{@atoo2}
\charge{45=\|,-45=\|,-135=\|,45:5pt=$\scriptstyle\ominus$}{0})}
\arrow(.mid east--.mid west){<->}
\chemfig{R-\charge{135:3pt=$\scriptstyle\oplus$}{N}([1]-\charge{90:3pt=$\scriptstyle\ominus$}{0})([7]=O)}
\schemestop
\chemmove{
\draw[shorten <=2pt, shorten >=2pt](db) ..controls +(120:5mm) and +(120:7mm)..(atoo1);
\draw[shorten <=3pt, shorten >=2pt](atoo2) ..controls +(225:10mm) and +(225:10mm)..(sb);
}
```

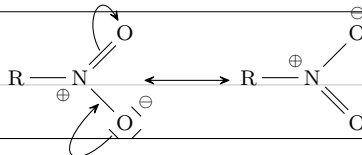

Nucleophilic addition. Primary amines

```
\setchemfig{atom sep=2.5em,compound sep=5em}
\schemestart
\chemfig{R-@{aton}\charge{90=\|}{N}H_2}
\+
\chemfig{@{atoc}C([3]-CH_3)([5]-CH_3)=[@{atoo1}]O}
\chemfig{@{atoo2}\chemabove{H}{\scriptstyle\oplus}}
\chemmove[-stealth,shorten <=3pt,dash pattern= on 1pt off 1pt,thin]{
\draw[shorten >=2pt](aton) ..controls +(up:10mm) and +(left:5mm)..(atoc);
\draw[shorten >=8pt](atoo1) ..controls +(up:10mm) and +(north west:10mm)..(atoo2);}
\arrow{<=>[\tiny addition]}
\chemfig{R-@{aton}\chembelow{N}{\scriptstyle\oplus}H([2]-[@{sb}]H)-C(-[2]CH_3)-([6]CH_3)-OH}
\schemestop
\chemmove{
\draw[-stealth,dash pattern= on 1pt off 1pt,shorten <=3pt, shorten >=2pt]
(sb) ..controls +(left:5mm) and +(135:2mm)..(aton);}
\par
\schemestart
\arrow{<=>}
\chemfig{R-@{aton}\charge{90=\|}{N}([6]-[@{sbh}]H)-[@{sb}]C(-[2]CH_3)-([6]CH_3)-[@{sbo}]{@atoo}
\chemabove{O}{\scriptstyle\oplus}(-[1]H)-([7]H)}
\chemmove[-stealth,shorten <=3pt,shorten >=2pt,dash pattern= on 1pt off 1pt,thin]{
\draw(aton) ..controls +(up:5mm) and +(up:5mm)..(sb);
\draw(sbh) ..controls +(left:5mm) and +(south west:5mm)..(aton);
\draw(sbo) ..controls +(up:5mm) and +(north west:5mm)..(atoo);}
\arrow{<=>[\tiny elimination]}\chemfig{R-N=C(-[1]CH_3)-([7]CH_3)}
\+
\chemfig{H_3\chemabove{O}{\scriptstyle\oplus}}
\schemestop
```

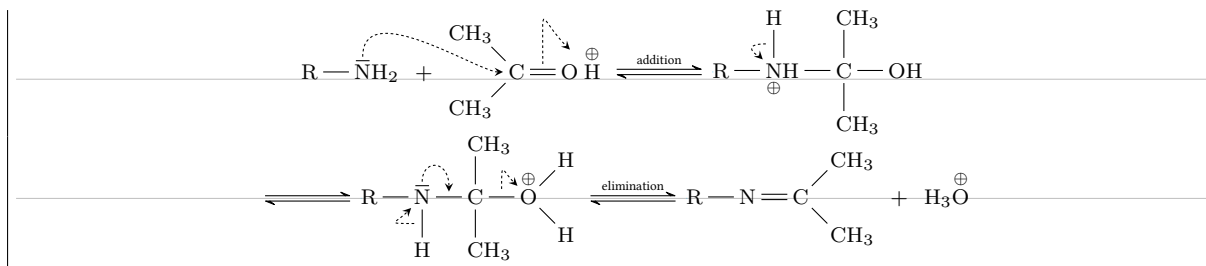

Reaction scheme

```

\setchemfig{atom sep=2em}
\schemestart[-90]
  \chemfig{*6(---(-NH_2)---)}\arrow{0}\chemfig{HNO_2}
  \merge(c1)(c2)--()
  \chemfig{*6(---(-N_2|{}^\oplus)---)}\arrow{0}\chemfig{*6(---(-NH_2)---)}
  \merge(c3)(c4)--()
  \chemfig{*6(---(-N[:::30]N-[::30])*6(---(-NH_2)---))---)}
\schemestop

```

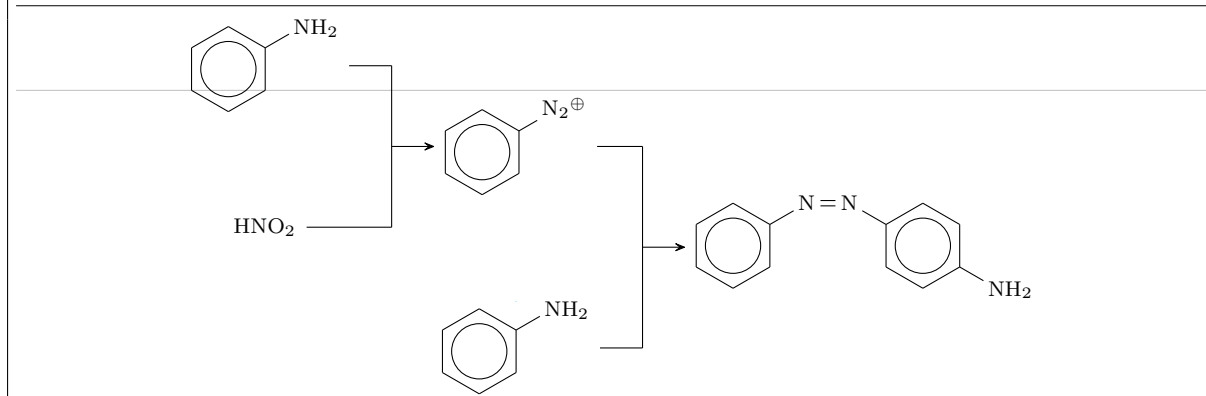

Addition

```

\setchemfig{atom sep=2.5em}
\schemestart
  \chemfig{*6(=-(=([2]O))}
  \arrow{->[\+\chemfig{H^\oplus}]}
  \chemleft[\\subscheme[90]{%
    \chemfig{*6(=-([2,0.33,,draw=none]\scriptstyle\oplus)-(-)-OH)}
    \arrow{<->}
    \chemfig{*6(=-(-([6,0.33,,draw=none]\scriptstyle\oplus)-OH))}\chemright]
  \arrow{@c3--}\chemfig{*6(=-([2]R)-(-)-OH)}
  \arrow{@c4--}\chemfig{*6(=-(-([6]R)-OH)}
\schemestop

```

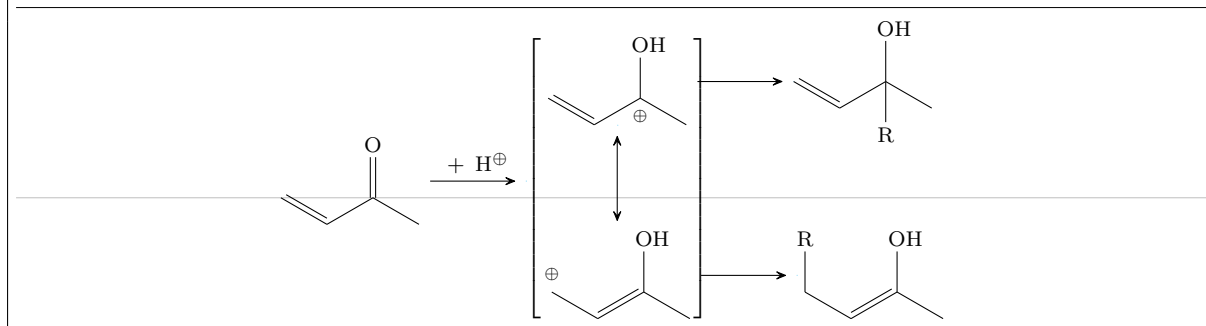

Electrophilic aromatic substitution

```

\setchemfig{atom sep=1.5em}%
\definesubmol{+}{-[:,-0.4,,draw=none]\oplus}%
\schemestart
  \arrow{0}[,0]
  \chemleft[\\subscheme{\chemfig{*6(=---(-[:120]Br)-[:60]H)-(!+)-)}
    \arrow{<->}
    \chemfig{*6(-(!+)-=-(-[:120]Br)-[:60]H)-=)}
    \arrow{<->}

```

```

\chemfig{*6(==(!+)-(-[:120]Br)(-[:60]H)-)}\chemright]
\arrow{@c2--}{<-[*0\chemfig{-}AlBr_4|^{\ominus}][*0\chemfig{Br_2/Al_2Br_3}][90,1.5]
\chemname{\chemfig{*6(==---)}{Benzene 1}
\arrow{@c4--}{->[*0\chemfig{-}H^{\oplus}][90,1.5]
\chemname{\chemfig{*6(==(-Br)-)}{Bromobenzne 2}
\arrow{@c5.mid east--@c6.mid west}
\chemestop
\chemnameinit{}

```

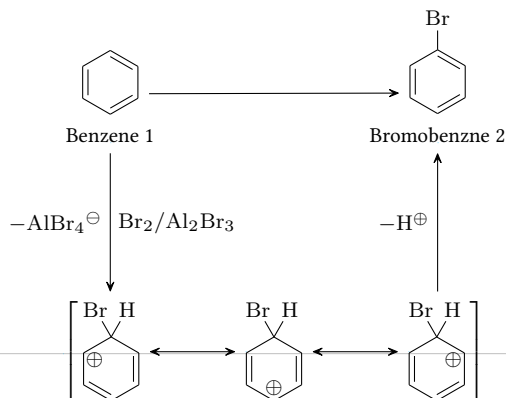

Reaction mechanism of chlorination

```

\scriptsize\setchemfig{bond offset=1pt,atom sep=2em,compound sep=4em}
\chemestart
\chemfig{Cl-[4]@{a0}(=[@{a1}:120]@{a2}O)-[:120](=[:-60]O)-[4]Cl}\+\chemfig{*6(==(-@{oh1}OH)-)}\arrow
\chemfig{*6((-[:150](-[@{o0}:150]@{o1}\charge{-90=\.}{O})(-[@{c10}:60]@{c11}Cl)-[:240](-[4]Cl)=[6]O)=-)}
\arrow\chemfig{*6((-[:150]([2]O)-[:150]([6]O)-[:150]Cl)=-)}\+\chemfig{HCl}
\arrow{@c1--}{0}[-90,0.5]
\chemfig{*6(==6(-@{o2}([@{o3}]@{o4}O)-Cl)=-)}\+\chemfig{*6(==(-@{oh2}OH)-)}\arrow
\chemfig{*6(==6(-(-[:120]@{c12}:60]@{c13}Cl)(-[@{o5}:-120]@{o6}\charge{-90=\.}{O})-[:40]*6(==---))=-)}
\kern-3em \arrow\chemfig{[:30]*6(-(-[:60]([=O)-[:120]([4]O)-[:60]O)*6(==---))=-)}
\kern-3em \+\chemfig{HCl}
\chemestop
\chemmove[line width=0.2pt,-stealth,dash pattern = on 2pt off 1pt]{
\draw[shorten <=2pt](a1)..controls+(200:5mm)and+(200:5mm)..(a2);
\draw[shorten >=2pt](oh1.west)..controls+(180:15mm)and+(60:5mm)..(a0);
\draw[shorten <=6pt,shorten >=2pt](o1)..controls+(270:5mm)and+(270:5mm)..(o0);
\draw[shorten <=2pt](c10)..controls+(150:5mm)and+(150:5mm)..(c11.150);
\draw[shorten <=2pt](o3)..controls+(30:3mm)and+(30:5mm)..(o4.east);
\draw[shorten >=2pt](oh2.135)..controls+(150:10mm)and+(90:10mm)..(o2);
\draw[shorten >=2pt,shorten <=5pt](xshift=-1.5mm)o6.315)..controls+(315:5mm)and+(315:5mm)..(o5);
\draw[shorten <=2pt](c12)..controls+(135:5mm)and+(135:5mm)..(c13.north west);}

```

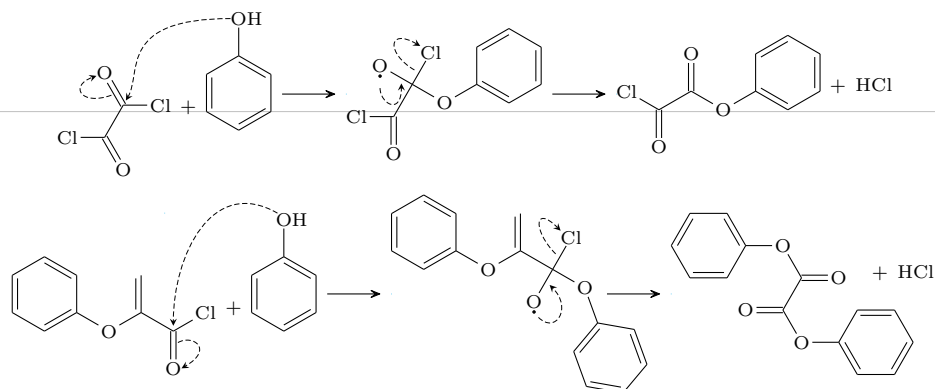

Cannizzaro reaction

```

\chemestart
\chemfig{[:30]*6(==(-@{atoc}C([6]=[@{db}]@{atoo1}O)-H)-)}
\arrow(start.mid east--.mid west){->[\chemfig{@{atoo2}\chemabove{0}{\scriptstyle\ominus}}H]}
\chemmove[-stealth,shorten >=2pt,dash pattern=on 1pt off 1pt,thin]{
\draw[shorten <=8pt](atoo2)..controls+(up:10mm)and+(up:10mm)..(atoc);
\draw[shorten <=2pt](db)..controls+(left:5mm)and+(west:5mm)..(atoo1);}
\chemfig{[:30]*6(==(-C([6]-[@{sb1}]@{atoo1}\chembelow{0}{\scriptstyle\ominus})([2]-OH)-[@{sb2}]H)-)}
\hspace{1cm}

```

```

\chemfig{[: -30]*6((-@{atoc}C[6]=[@{db}]@{atoo2}O)-[2]H)-==)}
\chemmove[-stealth,shorten <=2pt,shorten >=2pt,dash pattern=on 1pt off 1pt,thin]{
  \draw([yshift=-4pt]atoo1.270) ..controls +(0:5mm) and +(right:10mm)..(sb1);
  \draw(sb2) ..controls +(up:10mm) and +(north west:10mm)..(atoc);
  \draw(db) ..controls +(right:5mm) and +(east:5mm)..(atoo2);}
\arrow{@start.base west--}{0}[-75,2]
}
\arrow
\chemfig{[: -30]*6(==(-C[1]-@{atoo2}O-@{sb}0@{atoh}H)([6]=O))-)}
\arrow{0}
\chemfig{[: -30]*6((-C(-[5]H)-[7]H)-[2]@{atoo1}\chemabove{0}{\scriptstyle\ominus})-==)}
\chemmove[-stealth,shorten >=2pt,dash pattern=on 1pt off 1pt,thin]{
  \draw[shorten <=7pt](atoo1.90) ..controls +(90:8mm) and +(up:10mm)..(atoh);
  \draw[shorten <=2pt](sb) ..controls +(up:5mm) and +(up:5mm)..(atoo2);}
\schemestop

```

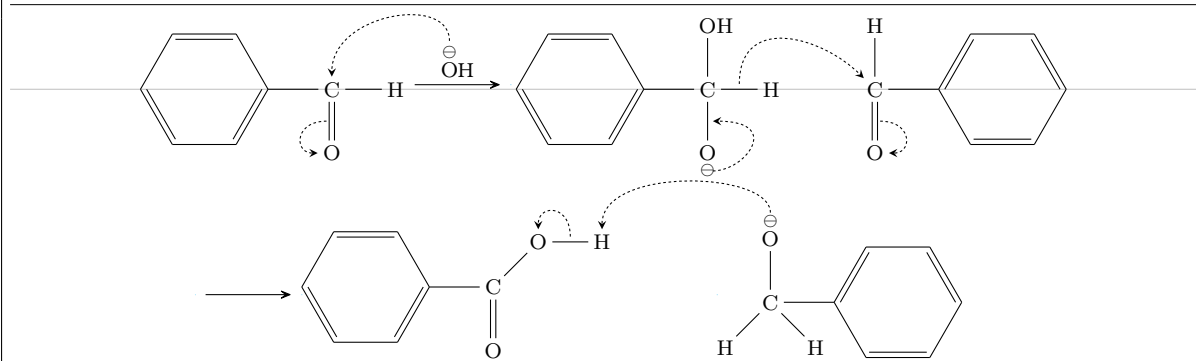

Beckmann rearrangement

```

\setchemfig{bond offset=1pt,atom sep=2.5em,compound sep=5em,arrow offset=6pt}
\schemestart
\chemfig{(-[: -150]R')(-[: -30]R)=[2]N-[: 30]OH}
\arrow{<=>[\chemfig{H^{\oplus}}]}
\chemfig{(-[: 0]@{a0}:-150]R')(-[: -30]R)=[2]@{a1}N-@{b0}[: 30]@{b1}\chemabove{0}{\scriptstyle\oplus}H_2}
\chemmove[red,-stealth,red,shorten <=2pt]{
  \draw(a0)..controls +(135:2mm) and +(215:4mm).. (a1);
  \draw(b0)..controls +(120:2mm) and +(180:3mm).. ([yshift=7pt]b1.180);}
\arrow{<=>[\chemfig{{-}H_2O}]}[1,1]
\chemleft[\subscheme{90}{%
  \chemfig{R'-\chemabove{N}{\scriptstyle\oplus}-C-R}
  \arrow{<->}[0.75]
  \chemfig{R'-\charge{90=:\}{N}=@{a1}\chemabove{C}{\scriptstyle\oplus}-R}\chemright]
\arrow{<=>[\chemfig{H_2@{a0}\charge{0=:\}{90=:\}{O}}]}[1,1]
\chemmove[red,-stealth,red,shorten <=3pt]{
  \draw(a0)..controls+(90:10mm)and+(45:10mm)..([yshift=6pt]a1.45);}
\arrow{@c1--}{0}[-90,0.333]
\chemfig{*6(R\rlap{ '$' }$)-N(-R)-\chemabove{0}{\scriptstyle\oplus} H_2}
\arrow{<=>[\chemfig{{-}H^{\oplus}}]}
\chemfig{*6(R\rlap{ '$' }$)-N(-R)-OH)}
\arrow
\chemfig{*6(R\rlap{ '$' }$)-\chembelow{N}{H}-(-R)(=[2]O))}
\schemestop

```

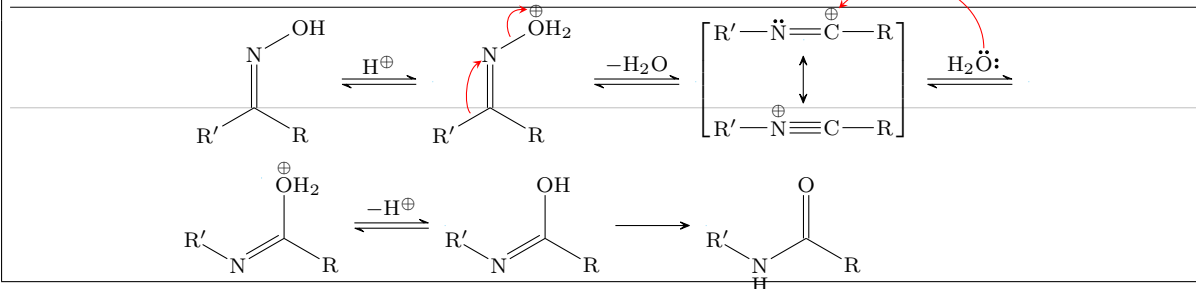

Reaction scheme

```

\setchemfig{atom sep=1.5em,compound sep=4em}
\schemestart
\chemfig{-[: :30]=_[: -60](-[: : -60])-[: :60]}
\arrow{->[\chemfig{HCl}]}
\chemfig{-[: :30]-[: -60](-[: :120]Cl)-[: -60]-[: :60]}\chemfig{-[: :30](-[: :60]Cl)-[: -60](-[: : -60])-[: :60]}

```

```

\arrow@c1--.north west}{->[\chemfig{H_2O}]}[-45,1.7]
\chemfig{-[:30]-[:60](-[:120]OH)(-[:60]-[:60])+\chemfig{-[:30](-[:60]OH)-[:60](-[:60]-[:60])}
\schemestop

```

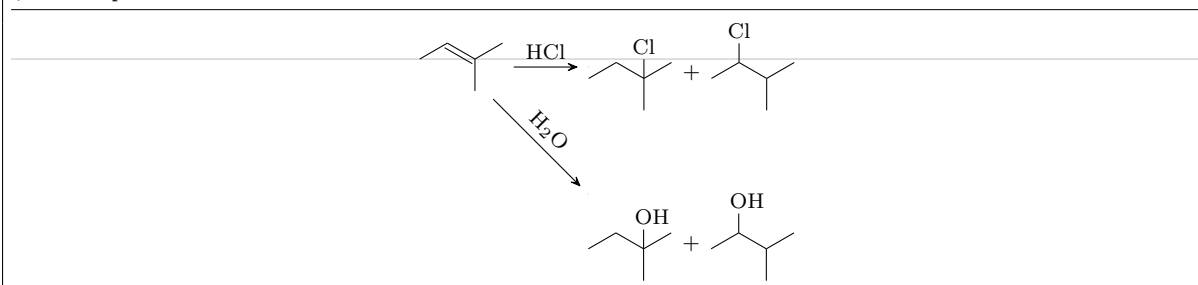

Esterification of formic acid

```

\tikzset{obrace/.style={left delimiter={[]},inner sep=3pt},
cbrace/.style={right delimiter={}],inner sep=3pt},
braces/.style={left delimiter={[]},right delimiter={}],inner sep=3pt}}
\setchemfig{atom sep=2em}
\schemestart
\chemfig{H-C(=[:60]O)-[:60]O-H}
\arrow{--M1[obrace]}{-U>[\scriptsize\chemfig{H_2SO_4^+}][\scriptsize\chemfig{HSO_4^-}][.25]}%
[.1.5,shorten >=6pt]
\chemfig{H-@{a2}C(-[:60]O-H)(-[:30].5,,draw=none){\scriptstyle\oplus}-[:60]O-H}
\arrow{--[cbrace]}{<->}
\chemfig{H-C(=[:60]\chemabove{O}{\scriptstyle\oplus})-H)-[:60]O-H}
\arrow{@M1--}{<=>[*0]\scriptsize\chemfig{H-[:120]@{a1}O-[:60]CH_3}[*0]\tiny addition}[-90,1.33]
\chemfig{H-C(-[:2]O-[:30]H)(-\chemabove{O}{\scriptstyle\oplus})(-[:60]CH_3)-[:60]H)-[6]O-[:30]H}
\arrow{<=>[\tiny protolysis]}[180]
\chemfig{H-C(-[:2]O-[:30]H)(-O-CH_3)-[@{b1}6]@{a3}\chemabove{O}{\kern-4mm\scriptstyle\oplus})(-[:150]H)-[:30]H}
\arrow{--[obrace]}{<=>[*0]\scriptsize\chemfig{{-}H_2O}[*0]\tiny elimination}[-90,,shorten >=6pt]
\chemfig{H-C(-[:60]O-H)(-[:.5,,draw=none){\scriptstyle\oplus})-[:60]O-CH_3}
\arrow{--[cbrace]}{<->}
\chemfig{H-C(=[:60]\chemabove{O}{\scriptstyle\oplus})-H)-[:60]O-CH_3}
\arrow{-U>[\scriptsize\chemfig{HSO_4^-}][\scriptsize\chemfig{H_2SO_4^+}][.25]}[.1.5]
\chemfig{H-C(=[:60]O)-[:60]O-CH_3}
\arrow{@M1--[yshift=-5pt]}{0}[180,.5]{\tiny protolysis}
\chemmove[red,shorten <=3pt,shorten >=1pt]{
\draw(a1)..controls +(0:1.5cm)and+(0:3cm).. (a2);
\draw(b1)..controls +(0:5mm)and+(20:5mm).. (a3);}
\schemestop

```

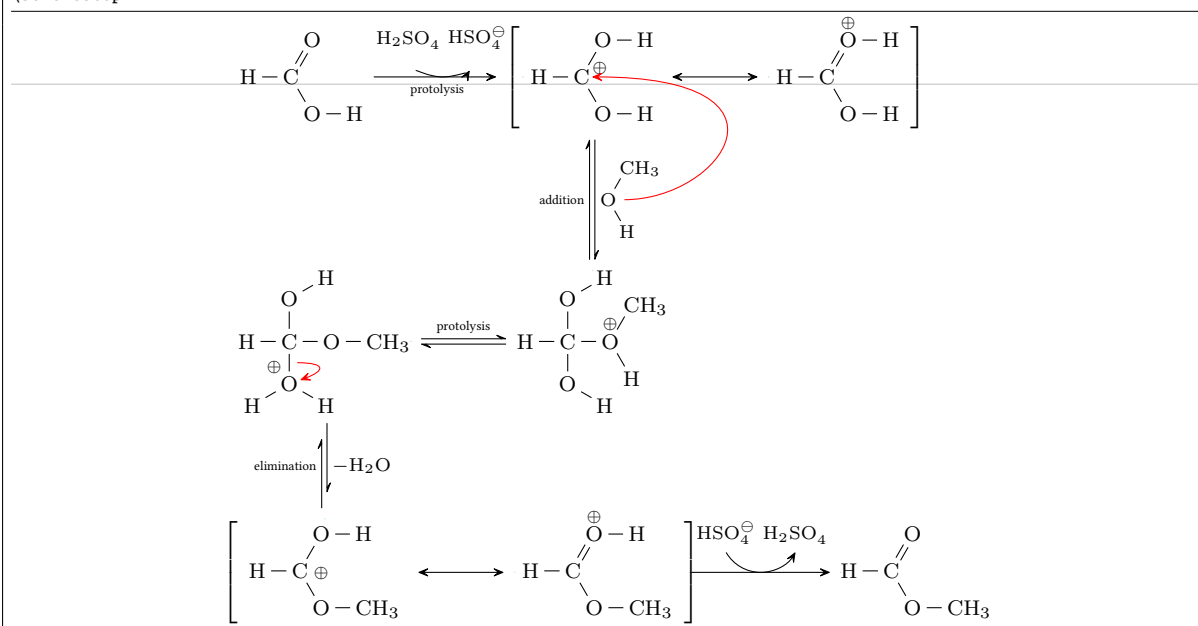

Electrophilic addition of halogen to olefin

```

\schemestart
\subscheme%
\chemfig{C(<[:40])(<[:160])=[6]C(<[:130])<[:20]}
\arrow{0}[,0]+\chemfig{\charge{90=\,180=\,270=\}{Br}-\charge{90=\,0=\,270=\}{Br}}

```

```

\arrow@c1--olefin}{<=>[*{0}rapide]}[-90]
\chemfig{>[: -20]C<[: 40]}=[@{db}6]C<[: -130]<[: -20]}
\arrow(--bromonium){0}[-90]
\chemname{\chemfig{C*3((<[: -155])-\charge{45=\|,-45=\|,180:3pt=$\scriptstyle\oplus$\{Br}-C(<[: 155])-)}\{bromonium ion}}
\arrow(--carbeniumA){<<->}[1.5]
\chemname{\chemfig{-[: -30]\chemabove{C}{\scriptstyle\oplus}(-[: 30])-[6]C<[: -150])(<[: -100])-[: -30]\charge{45=\|,-45=\|,225=\|}\{Br}\}\{Xarbenium ion}}
\arrow(@bromonium--carbeniumB){<<->}[180,1.5]
\chemname{\chemfig{-[: -30]\chemabove{C}{\scriptstyle\oplus}(-[: 30])-[6]C<[: -150])(<[: -100])-[: -30]\charge{45=\|,-45=\|,135=\|}\{Br}\}\{carbenium ion}}
\arrow(@olefin--){0}[.25]
\chemfig{@{Br1}\charge{90=\|,180=\|,270=\|,90:5pt=$\scriptstyle\delta\oplus$\{Br}-[@{b2}]{Br2}\charge{90=\|,0=\|,270=\|,90:5pt=$\scriptstyle\delta\ominus$\{Br}}\}
\arrow(@olefin--[left]){0}[180,0]
$\pi$ complexe
\arrow(@carbeniumA--@olefin){<=>[lent, \chemfig{{-}Br^\ominus}]}
\arrow(@carbeniumB--@olefin){<=>[lent, \chemfig{{-}Br^\ominus}]}
\chemmove[-stealth,red,shorten <=3pt,shorten >=2pt]{
\draw(db) .. controls +(20:5mm) and +(135:5mm) .. (Br1);
\draw(b2) .. controls +(-90:5mm) and +(-120:5mm) .. (Br2);}
\schemestop
\chemnameinit{}

```

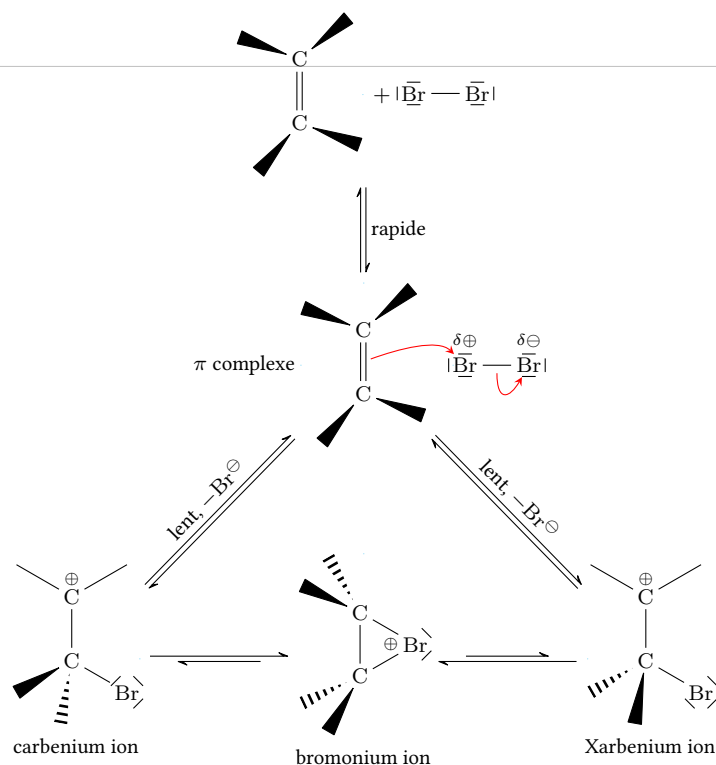

Sulfonation of naphthalene

```

\definesubmol\cycleoplus{-[,0.25,,draw=none]\oplus}
\definesubmol{so2oh}{S(=[:90]O)(=[: -90]O)-OH}
\setchemfig{atom sep=2.5em}
\schemestart[,1.5]
\chemname{\chemfig{*6(=*6(==*)=*)}\{Naphtalene}\+\chemfig{H_2SO_4}}
\arrow(nph.mid east--.south west){->[80\degres C]}[45]
\chemname{\chemfig{*6(=*6(==*)=*)}\{Ion 1-arenium}}
\arrow(.mid east--.mid west)
\chemname{\chemfig{*6(=*6(==*)=*)}\{Acide 1-naphthalenesulfonique}}
\arrow(@nph.mid east--.north west){->[160\degres C]}[-45]
\chemname{\chemfig{*6(=*6(==*)=*)}\{Ion 2-arenium}\kern-4em}
\arrow(.mid east--.mid west)
\chemname{\chemfig{*6(=*6(==*)=*)}\{Acide 2-naphthalenesulfonique}}
\schemestop
\chemnameinit{}

```

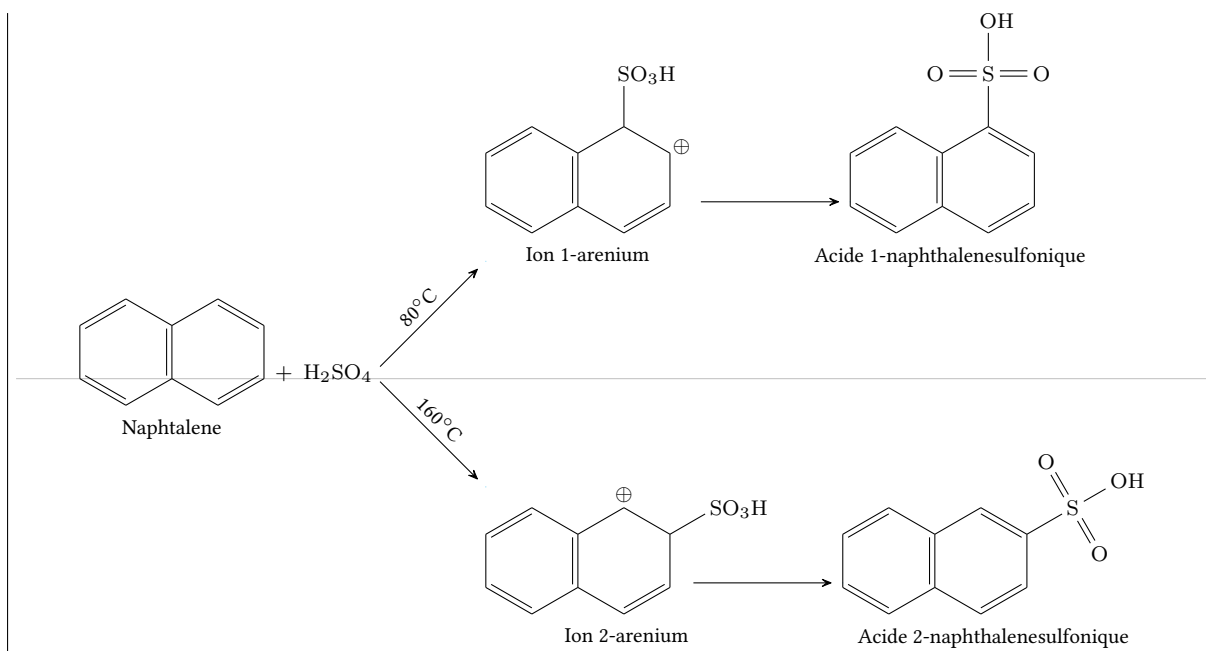
Explanatory diagram

```

\parbox{0.8\linewidth}{%
  \hspace{10em}
  \tikz[remember picture]\node(n0){\chemname{}}{\text{Attacks}\nucleophiles}};\par
  \vspace{2ex}\hspace{15em}
  \chemfig{R^2-(-[: -60]{m3}H)-[:60]{m0}\charge{45:5pt={\scriptstyle\color{red}\delta+}}{(-[:120]R^1)}
    =[:m1]{m2}\charge{45=:\:, -45=:\:, 45:7pt={\scriptstyle\color{red}\delta-}}{O}}
  \hspace{5em}
  \chemname[-15ex]{\tikz[remember picture]\node(n1){};\text{Addition reactions}}\kern1em
  \chemname{\tikz[remember picture]\node(n2){};\text{Basic properties}}\par
  \vspace{6ex}\hspace{8em}
  \chemname{\text{Acidic properties of hydrogen}\tikz[remember picture]\node(n3){};
    \atom in $\alpha$ position}
  \chemmove[-stealth, line width=0.8pt, green!60!black!70]{
    \draw[shorten >=2pt](n0)..controls+(270:4em)and+(180:2em)..(a1);
    \draw[shorten >=8pt](n1)..controls+(180:2em)and+(60:2em)..(a2);
    \draw[shorten >=5pt](n2)..controls+(180:2em)and+(270:2em)..([xshift=3pt]a3.315);
    \draw[shorten >=2pt](n3)..controls+(0:2em)and+(270:2em)..(a0);
  }%
}
\chemnameinit{}
  
```

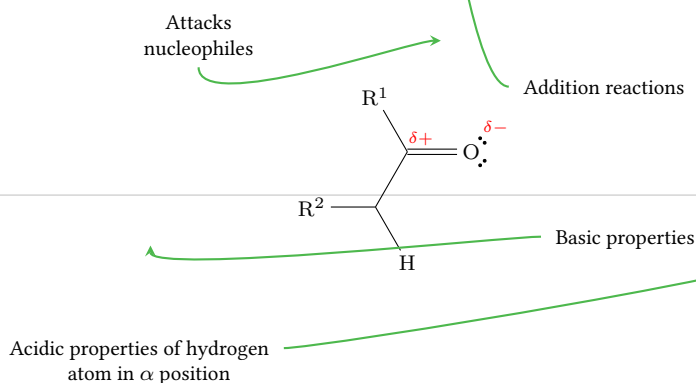

Taxotere

```

\chemfig{-[: -30](-[:5])(-[:7])-[: +60]-[: -60]O-[: +60](=[: -45]O)-[: +90]HN>[: -60](-[: +60]**6(-----))
-[: -30](<[:2]OH)-[: -60](=[:6]O)-[: +60]O>[: -60]*7(---?<[: -120]OH)-<[:1]CH_3)<[: -90]CH_3)
-[: -1](<[: +80]HO)-[:0](=[: +60]O)-[:7](<[: +130]CH_3)-[: +75](<[:2]OH)-[: -60]-[: -60](<[: +30]O-[: -90])
-[: -60](<[: +90])<[: +30]O-[:7](-[:6]CH_3)=[:0]O)-[: -60]-[:6]-[:5,1.3]?<[:7]O-[:5](=[: -60]O)
-[:6]**6(-----))=[:2]CH_3)-}
  
```

